

Hardware

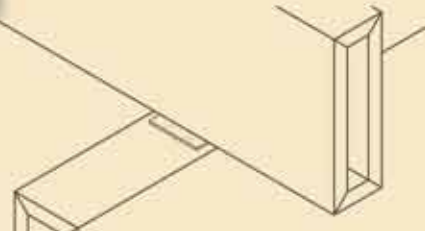

Flat Aluminum Rafter Bracket



Rafter Bracket Installed

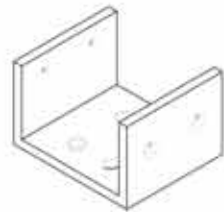

Carrying Beam Bracket

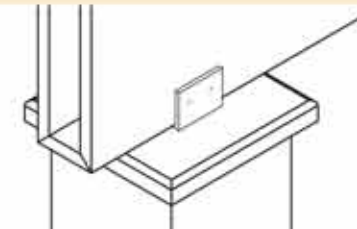

Carrying Beam Bracket Installed



Ledger Board Bracket

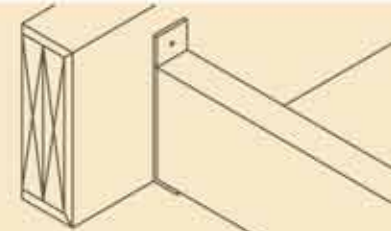

Ledger Board Bracket Installed

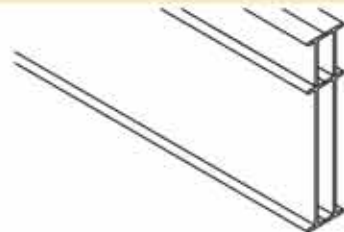

Carrying Beam Aluminum I-Beam

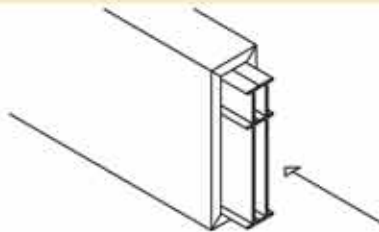

Aluminum I-Beam Installed

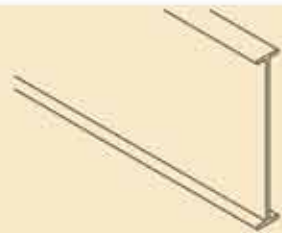

Rafter Beam Aluminum I-Beam

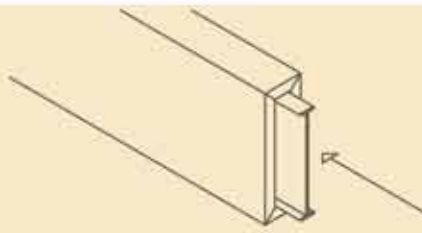

Aluminum I-Beam Installed

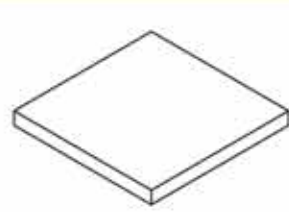

Optional Post Cap

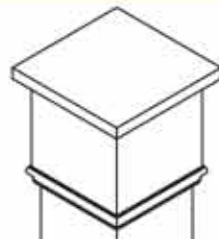

Optional Post Cap Installed

*See product literature for complete Post Wrap offering available on our web site

Visit us at www.intexmillwork.com

INTEX Finishing Procedure

Intex Millwork products are Manufactured from PVC trim board, which is UV-resistant and does not require painting for protection. The products may be painted to achieve a custom color.. Use exterior 100% acrylic paint.

Caution: To decrease the chance of separation due to expansion/contraction, do not paint Intex Millwork products dark colors where they will be exposed to direct sunlight.

(Paint should have a light reflective value of 55 or greater)

For more information visit us at:
www.intexmillwork.com
or 609.567.5900
fax 609.567.5901
34 West Black Horse Pike
Williamstown, NJ 08094

©2008 INTEX Millwork Solutions. All Rights Reserved.

"INTEX" is a registered trademark of INTEX Millwork Solutions.
INTEXPERGOLA

Pergolas

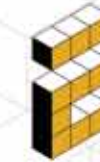

INTEX[®]
MILLWORK SOLUTIONS

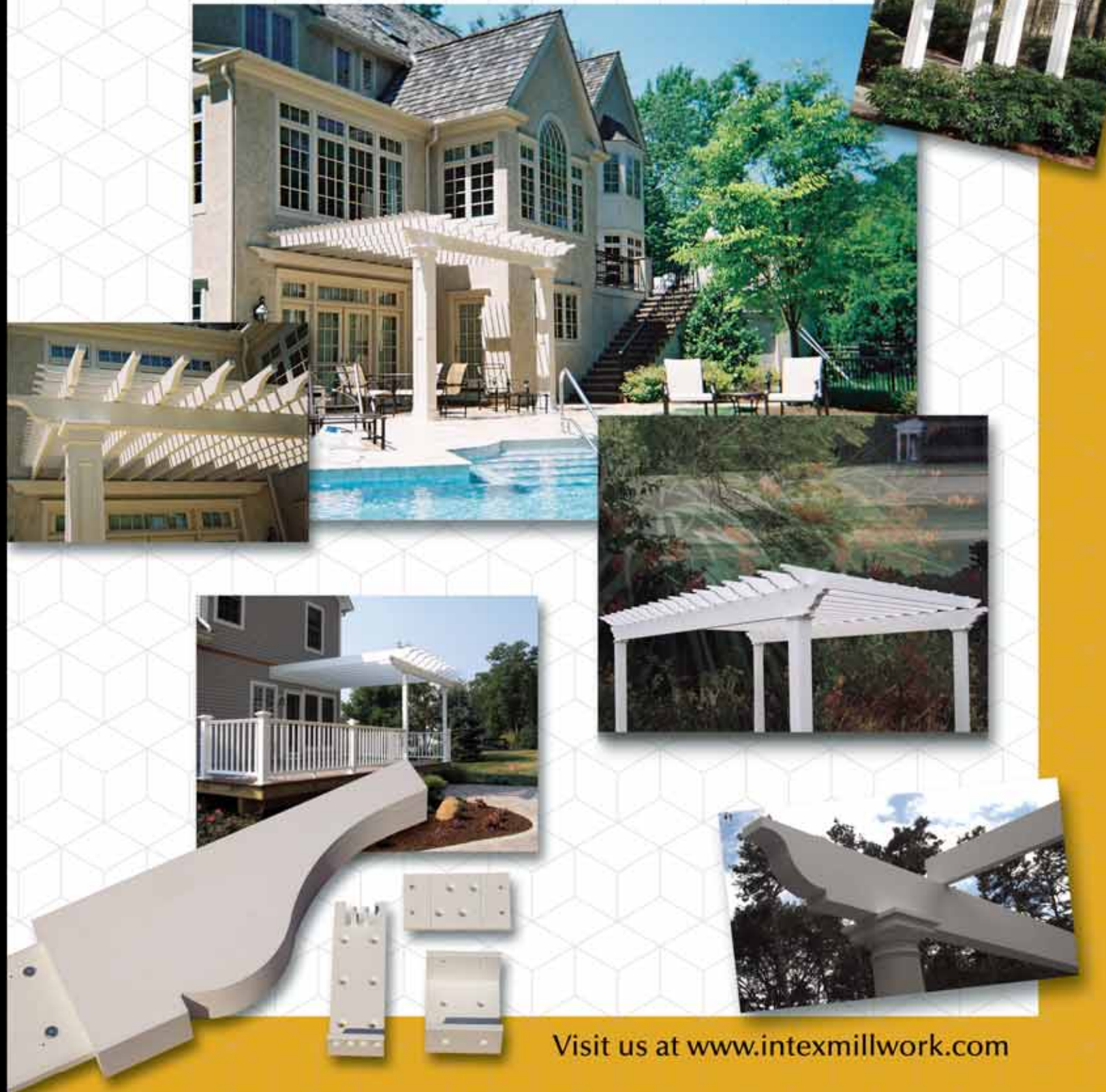

Visit us at www.intexmillwork.com

Beam Sizes

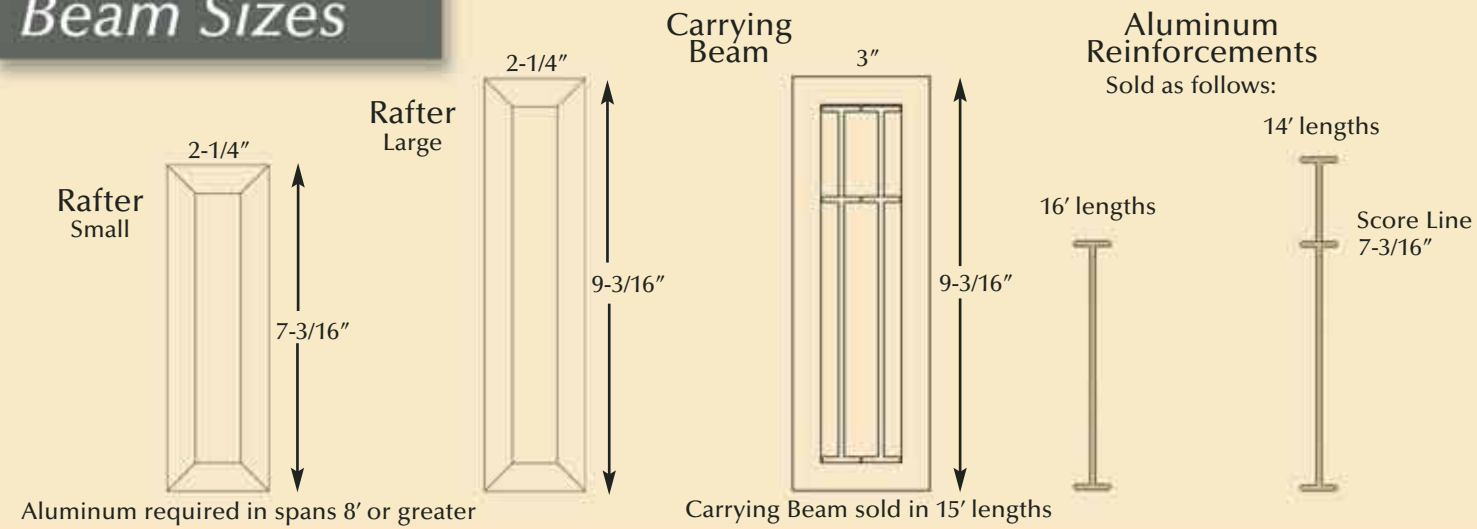

Tail Designs

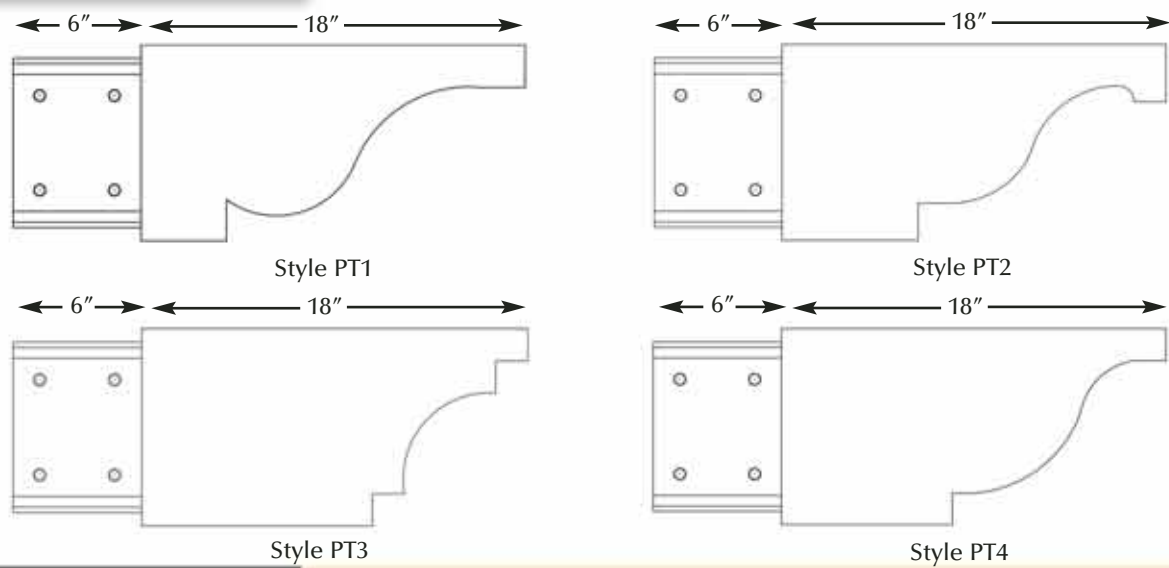

Other Profiles

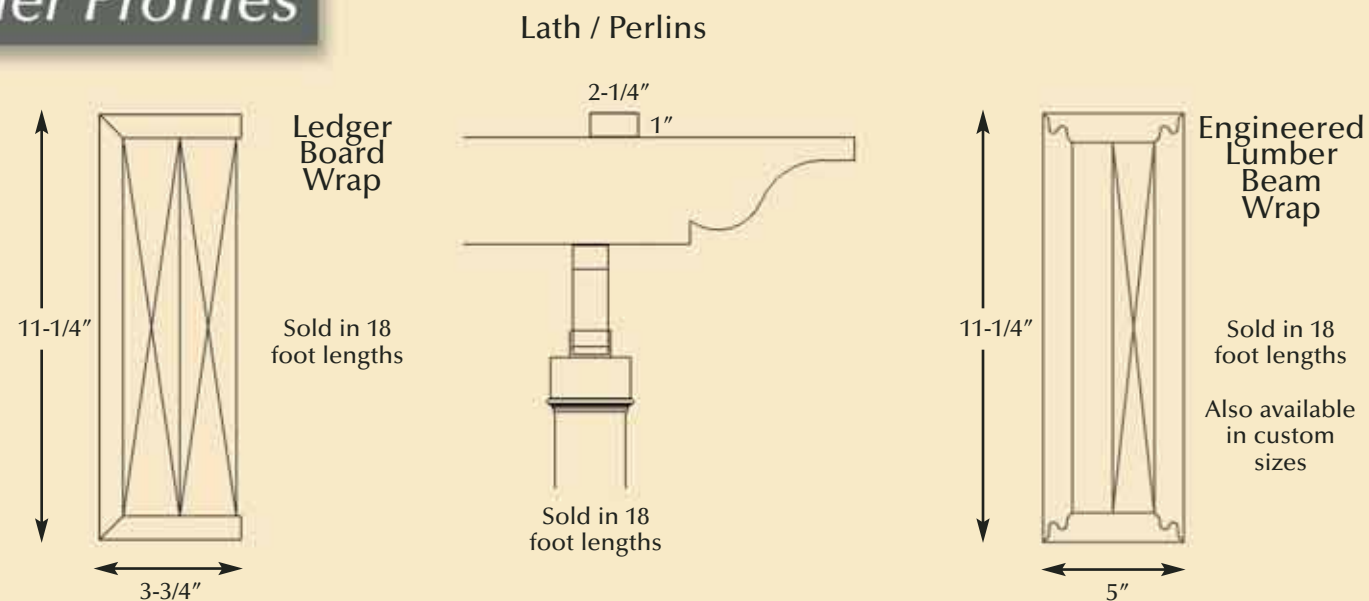

Specifications

NOTE: Aluminum reinforcement required in rafter spans 8' or greater. Under 8' is suggested

Rafter Beam Deflection		6'	8'	10'	12'	14'
7-3/16"	Deflection - Un-Reinforced	.008	.024	.058	.121	.223
	With Aluminum I-Beam	.001	.004	.009	.020	.036
9-3/16"	Deflection - Un-Reinforced	.012	.038	.093	.193	.358
	With Aluminum I-Beam	.002	.005	.012	.025	.047
Carrying Beam Deflection						
Length of Support Beam		6'	8'	10'	12'	14'
6 Foot Rafters		.002	.007	.016	.033	.059
8 Foot Rafters		.003	.011	.026	.054	.086
10 Foot Rafters		.004	.013	.031	.066	.104
12 Foot Rafters		.005	.015	.037	.077	.122
14 Foot Rafters		.006	.018	.041	.087	.137

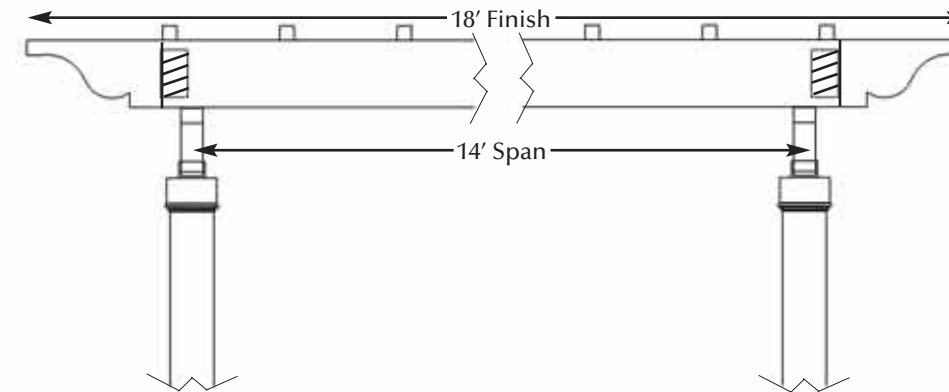

Click on Q²



Choose your product



COMING SOON to Quick Quote, Our New On-Line Pergola Price Configurator

Soon our web based Window Surround pricing configurator will feature **PART 2** in development, a quick and easy to use **Column and Pergola Configurator**.

Look for it soon on our web site.

INTEX Pergola Systems

INTEX provides pre-sized cut to length parts, for a complete Pergola System.

Engineered Lumber Beam Wrap sized to wrap field installed framing members

Ledger Board Wrap available in 18 foot lengths, designed to cover 2" x 10" ledger framing member

Clear spans exceeding 12 feet require aluminum reinforcements, (sold separately)

Pergola Rafters available in 7-3/16" x 2-1/4" x 15' or 18' or 9-3/16" x 2-1/4" x 15' or 18' lengths. designed to be field trimmed

4 optional tail designs available in each height

