

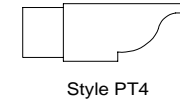

**Carrying Beam, Rafter and Purlin Tails are now available factory assembled at no additional cost.**  
**Maximum tip to tip length is 18'**

Tail Designs for Beams and Rafters

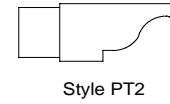
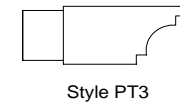
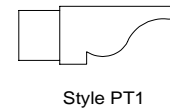

**INTEX PERGOLA SYSTEM**

Item #	Size	Outside Width 'W'	Outside Height 'H'	Inside Width 'w'	Inside Height 'h'	Length	List Price	Illustration	Full Pallet Qty
--------	------	-------------------	--------------------	------------------	-------------------	--------	------------	--------------	-----------------

Pergola Rafters

PER2718R	2 1/4" X 7 3/16" X 18' Length	2 1/4"	7 3/16"	1"	5 15/16"	216"	\$583.39		
PER2715R	2 1/4" X 7 3/16" X 15' Length	2 1/4"	7 3/16"	1"	5 15/16"	180"	\$505.64		
PER2918R	2 1/4" X 9 3/16" X 18' Length	2 1/4"	9 3/16"	1"	5 15/16"	216"	\$583.39		
PER2915R	2 1/4" X 9 3/16" X 15' Length	2 1/4"	9 3/16"	1"	5 15/16"	180"	\$505.64		

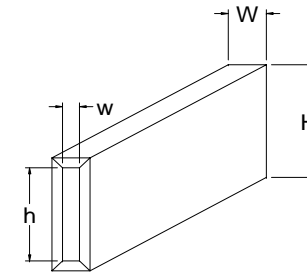

36
36
30
30

Pergola Rafter Decorative Tails

PER27PT1	2 1/4" X 7 3/16" X 18" Length	2 1/4"	7 3/16"	N/A	N/A	18"	\$173.75		
PER27PT2	2 1/4" X 7 3/16" X 18" Length	2 1/4"	7 3/16"	N/A	N/A	18"	\$173.75		
PER27PT3	2 1/4" X 7 3/16" X 18" Length	2 1/4"	7 3/16"	N/A	N/A	18"	\$173.75		
PER27PT4	2 1/4" X 7 3/16" X 18" Length	2 1/4"	7 3/16"	N/A	N/A	18"	\$173.75		
PER29PT1	2 1/4" X 9 3/16" X 18" Length	2 1/4"	9 3/16"	N/A	N/A	18"	\$180.41		
PER29PT2	2 1/4" X 9 3/16" X 18" Length	2 1/4"	9 3/16"	N/A	N/A	18"	\$180.41		
PER29PT3	2 1/4" X 9 3/16" X 18" Length	2 1/4"	9 3/16"	N/A	N/A	18"	\$180.41		
PER29PT4	2 1/4" X 9 3/16" X 18" Length	2 1/4"	9 3/16"	N/A	N/A	18"	\$180.41		

See Designs At Top Of Page

40
40
40
40
40
40
40
40



**Carrying Beam, Rafter and Purlin Tails are now available factory assembled at no additional cost.**  
**Maximum tip to tip length is 18'**

**Tail Designs for Beams and Rafters**

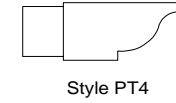
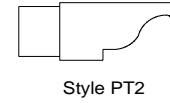
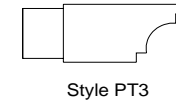
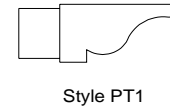

**INTEX PERGOLA SYSTEM**

Item #	Size	Outside Width 'W'	Outside Height 'H'	Inside Width 'w'	Inside Height 'h'	Length	List Price	Illustration	Full Pallet Qty
--------	------	-------------------	--------------------	------------------	-------------------	--------	------------	--------------	-----------------

**Structural Carrying Beam**

PER3915SCB	3" X 9 3/16" X 15' Length	3"	9 3/16"	1.75"	7 15/16"	180"	\$974.67		
------------	---------------------------	----	---------	-------	----------	------	----------	--	--

*Note: Includes Aluminum Reinforcement*

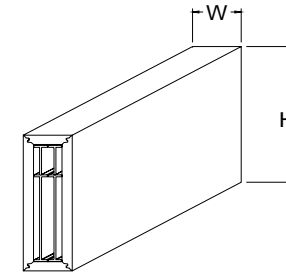

12

**Structural Carrying Beam Decorative Tails**

PER39PT1	3" X 9 3/16" X 18" Length	2 1/4"	9 3/16"	N/A	N/A	18"	\$227.44		12
PER39PT2	3" X 9 3/16" X 18" Length	2 1/4"	9 3/16"	N/A	N/A	18"	\$227.44		12
PER39PT3	3" X 9 3/16" X 18" Length	2 1/4"	9 3/16"	N/A	N/A	18"	\$227.44		12
PER39PT4	3" X 9 3/16" X 18" Length	2 1/4"	9 3/16"	N/A	N/A	18"	\$227.44		12

See Designs At Top Of Page

**Extended Span Structural Carrying Beam**

PER61220ESCB	6" X 12" X Up To 20' Length	6"	12"	4"	10"	<=20'	\$2,765.94		
--------------	-----------------------------	----	-----	----	-----	-------	------------	--	--

*Note: Includes Aluminum Reinforcement. Specify span length (up to 20') and tail pattern (see below) selection when ordering.*

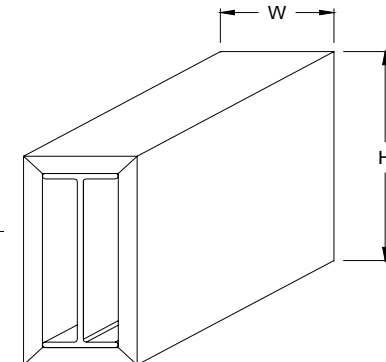

N/A



**Carrying Beam, Rafter and Purlin Tails are now available factory assembled at no additional cost.  
Maximum tip to tip length is 18'**

**Tail Designs for Beams and Rafters**

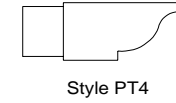
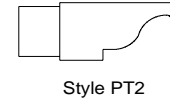
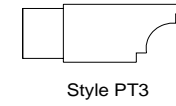
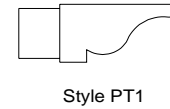

**INTEX PERGOLA SYSTEM**

Item #	Size	Outside Width 'W'	Outside Height 'H'	Inside Width 'w'	Inside Height 'h'	Length	List Price	Illustration	Full Pallet Qty
--------	------	-------------------	--------------------	------------------	-------------------	--------	------------	--------------	-----------------

**Extended Span Structural Carrying Beam Decorative Tails**

PER612PT1	6" X 12" X 18" Length	6	12	N/A	N/A	18"	\$450.94	See Designs At Top Of Page	N/A
PER612PT2	6" X 12" X 18" Length	6	12	N/A	N/A	18"	\$450.94		N/A
PER612PT3	6" X 12" X 18" Length	6	12	N/A	N/A	18"	\$450.94		N/A
PER612PT4	6" X 12" X 18" Length	6	12	N/A	N/A	18"	\$450.94		N/A

**Note: Decorative Tails for Extended Span Carrying Beam are only sold shop installed to the beam. Prices (per Tail) include installation.**

**Decorative Hollow Purlin**

PER2418PUR	2" X 4" X 18' Length	2"	4"	1-1/4"	3-1/4"	216"	\$280.95	See Designs At Top Of Page	N/A
------------	----------------------	----	----	--------	--------	------	----------	----------------------------	-----

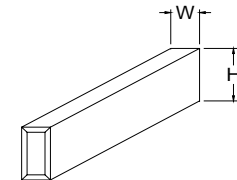

**Hollow Purlin Decorative Tails**

PER24PT1	2" x 4" x 7-3/4" Length	2"	4"	N/A	N/A	7-3/4"	\$123.53	See Designs At Top Of Page	N/A
PER24PT2	2" x 4" x 7-3/4" Length	2"	4"	N/A	N/A	7-3/4"	\$123.53		N/A
PER24PT3	2" x 4" x 7-3/4" Length	2"	4"	N/A	N/A	7-3/4"	\$123.53		N/A
PER24PT4	2" x 4" x 7-3/4" Length	2"	4"	N/A	N/A	7-3/4"	\$123.53		N/A



Carrying Beam, Rafter and Purlin Tails are now available factory assembled at no additional cost.  
Maximum tip to tip length is 18'

Tail Designs for Beams and Rafters

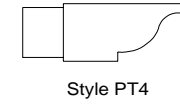
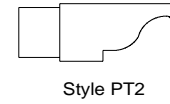
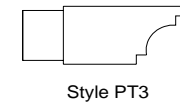
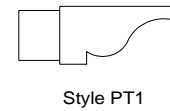

**INTEX PERGOLA SYSTEM**

Item #	Size	Outside Width 'W'	Outside Height 'H'	Inside Width 'w'	Inside Height 'h'	Length	List Price	Illustration	Full Pallet Qty
--------	------	-------------------	--------------------	------------------	-------------------	--------	------------	--------------	-----------------

Standard Pergola Lath

PER1218LATH	1" x 2.25" x 18' Length	2 1/4"	1"	N/A	N/A	216"	\$50.40		
-------------	-------------------------	--------	----	-----	-----	------	---------	--	--

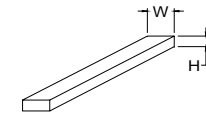

50

Pergola Rafter Aluminum Insert

PERINSERT7	1" X 6" X 16' Length	1"	6"	N/A	N/A	192"	\$213.33		
PERINSERT9	1" X 8" X 14' Length	1"	8"	N/A	N/A	168"	\$213.33		

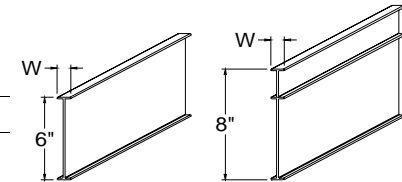

36  
36

Engineered Lumber Beam Cover

PER51118SBC	5" X 11 1/4" X 18' Length	5"	11 1/4"	3 3/4"	10"	216"	\$823.84		
-------------	---------------------------	----	---------	--------	-----	------	----------	--	--

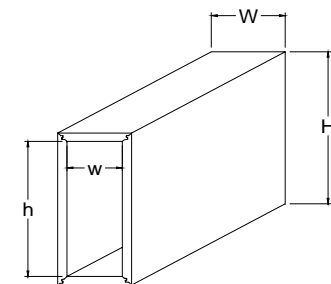

6



**Carrying Beam, Rafter and Purlin Tails are now available factory assembled at no additional cost.**  
**Maximum tip to tip length is 18'**

**Tail Designs for Beams and Rafters**

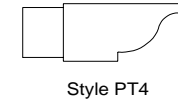
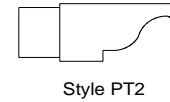
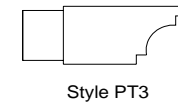
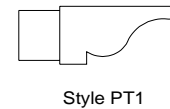

**INTEX PERGOLA SYSTEM**

Item #	Size	Outside Width 'W'	Outside Height 'H'	Inside Width 'w'	Inside Height 'h'	Length	List Price	Illustration	Full Pallet Qty
--------	------	-------------------	--------------------	------------------	-------------------	--------	------------	--------------	-----------------

**Engineered Lumber Beam Cover Decorative Tails**

PER511PT1	5" X 11 1/4" X 18"	5"	11 1/4"	N/A	N/A	18"	\$297.37	See Designs At Top Of Page	12
PER511PT2	5" X 11 1/4" X 18"	5"	11 1/4"	N/A	N/A	18"	\$297.37		12
PER511PT3	5" X 11 1/4" X 18"	5"	11 1/4"	N/A	N/A	18"	\$297.37		12
PER511PT4	5" X 11 1/4" X 18"	5"	11 1/4"	N/A	N/A	18"	\$297.37		12

**Ledger Board Cover**

PER21118LBC	3 3/4" X 11 1/4" X 18' Length	3 3/4"	11 1/4"	3 1/8"	10"	216"	\$519.77		12
-------------	-------------------------------	--------	---------	--------	-----	------	----------	--	----

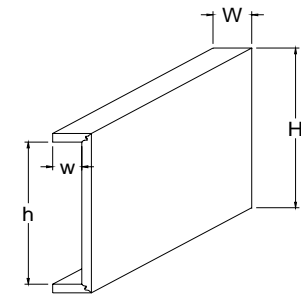

**Post/Column Top Cover**

PERPOST6	Top Cover for 6" Post/Column	8-3/4"	1"	N/A	N/A	N/A	\$34.92		16
PERPOST8	Top Cover for 8" Post/Column	10-3/4"	1"	N/A	N/A	N/A	\$39.96		16
PERPOST10	Top Cover for 10" Post/Column	12-3/4"	1"	N/A	N/A	N/A	\$46.05		16
PERPOST12	Top Cover for 12" Post/Column	14-3/4"	1"	N/A	N/A	N/A	\$53.17		16



**Carrying Beam, Rafter and Purlin Tails are now available factory assembled at no additional cost.**  
**Maximum tip to tip length is 18'**

Tail Designs for Beams and Rafters

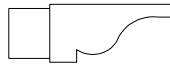

Style PT1



Style PT3



Style PT2



Style PT4

**INTEX PERGOLA SYSTEM**

Item #	Size	Outside Width 'W'	Outside Height 'H'	Inside Width 'w'	Inside Height 'h'	Length	List Price	Illustration	Full Pallet Qty
--------	------	-------------------	--------------------	------------------	-------------------	--------	------------	--------------	-----------------

**Brackets & Screws**

PERCBBKT	Carrying Beam Bracket	N/A	N/A	N/A	N/A	N/A	\$37.78		24
PERRABKT	Rafter Bracket	N/A	N/A	N/A	N/A	N/A	\$16.67		150
PERRAMTBKT	Ledger Board Rafter Bracket	N/A	N/A	N/A	N/A	N/A	\$47.78		50
PERESCBBKT	Extended Span Carrying Beam Mounting Bracket w/Screws	N/A	N/A	N/A	N/A	N/A	\$80.14		N/A
PER1015SCR	Bag of 150, #10 X 1.5" Stainless Self Tapping Screws (White Heads)	N/A	N/A	N/A	N/A	N/A	\$95.56		20
PERPURSCR	4-1/2" Screws for Hollow Purlin, Bag of 50 w/Bit	N/A	N/A	N/A	N/A	N/A	\$78.20		N/A
PERTB250T10	250 ml Cartridge TrimBonder 2-Part Epoxy (w/10 Applicator Tips)	N/A	N/A	N/A	N/A	N/A	\$67.86		N/A

**See Our Other Literature (Or On-Line At [www.intexmillwork.com](http://www.intexmillwork.com)) For Post Wrap Kits And Decorative Columns To Compliment The Intex Pergola System**