

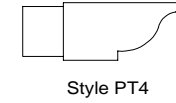

Note: Carrying Beam, Rafter and Purlin Tails are now available factory assembled. For pricing, add list price of tail(s) to list price of Beam, Rafter or Purlin and multiply by 1.1.

Tail Designs for Beams and Rafters

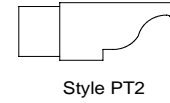
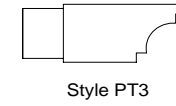
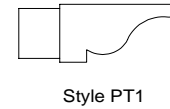

INTEX PERGOLA SYSTEM

Item #	Size	Outside Width 'W'	Outside Height 'H'	Inside Width 'w'	Inside Height 'h'	Length	List Price	Illustration	Full Pallet Qty
--------	------	-------------------	--------------------	------------------	-------------------	--------	------------	--------------	-----------------

Pergola Rafters

PER2718R	2 1/4" X 7 3/16" X 18' Length	2 1/4"	7 3/16"	1"	5 15/16"	216"	\$583.39		
PER2715R	2 1/4" X 7 3/16" X 15' Length	2 1/4"	7 3/16"	1"	5 15/16"	180"	\$505.64		
PER2918R	2 1/4" X 9 3/16" X 18' Length	2 1/4"	9 3/16"	1"	5 15/16"	216"	\$583.39		
PER2915R	2 1/4" X 9 3/16" X 15' Length	2 1/4"	9 3/16"	1"	5 15/16"	180"	\$505.64		

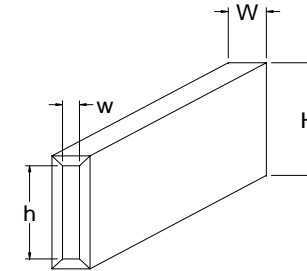

36
36
30
30

Pergola Rafter Decorative Tails

PER27PT1	2 1/4" X 7 3/16" X 18" Length	2 1/4"	7 3/16"	N/A	N/A	18"	\$173.75		
PER27PT2	2 1/4" X 7 3/16" X 18" Length	2 1/4"	7 3/16"	N/A	N/A	18"	\$173.75		
PER27PT3	2 1/4" X 7 3/16" X 18" Length	2 1/4"	7 3/16"	N/A	N/A	18"	\$173.75		
PER27PT4	2 1/4" X 7 3/16" X 18" Length	2 1/4"	7 3/16"	N/A	N/A	18"	\$173.75		
PER29PT1	2 1/4" X 9 3/16" X 18" Length	2 1/4"	9 3/16"	N/A	N/A	18"	\$180.41		
PER29PT2	2 1/4" X 9 3/16" X 18" Length	2 1/4"	9 3/16"	N/A	N/A	18"	\$180.41		
PER29PT3	2 1/4" X 9 3/16" X 18" Length	2 1/4"	9 3/16"	N/A	N/A	18"	\$180.41		
PER29PT4	2 1/4" X 9 3/16" X 18" Length	2 1/4"	9 3/16"	N/A	N/A	18"	\$180.41		

See Designs At Top Of Page

40
40
40
40
40
40
40
40



Note: Carrying Beam, Rafter and Purlin Tails are now available factory assembled. For pricing, add list price of tail(s) to list price of Beam, Rafter or Purlin and multiply by 1.1.

Tail Designs for Beams and Rafters

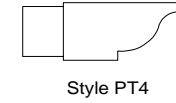
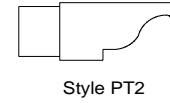
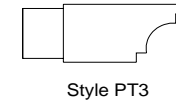
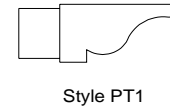

INTEX PERGOLA SYSTEM

Item #	Size	Outside Width 'W'	Outside Height 'H'	Inside Width 'w'	Inside Height 'h'	Length	List Price	Illustration	Full Pallet Qty
--------	------	-------------------	--------------------	------------------	-------------------	--------	------------	--------------	-----------------

Structural Carrying Beam

PER3915SCB	3" X 9 3/16" X 15' Length	3"	9 3/16"	1.75"	7 15/16"	180"	\$974.67		
------------	---------------------------	----	---------	-------	----------	------	----------	--	--

Note: Includes Aluminum Reinforcement

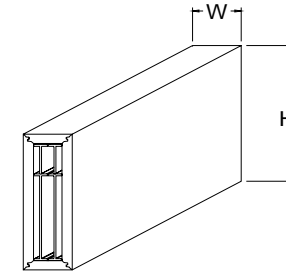

12

Structural Carrying Beam Decorative Tails

PER39PT1	3" X 9 3/16" X 18" Length	2 1/4"	9 3/16"	N/A	N/A	18"	\$227.44		12
PER39PT2	3" X 9 3/16" X 18" Length	2 1/4"	9 3/16"	N/A	N/A	18"	\$227.44		12
PER39PT3	3" X 9 3/16" X 18" Length	2 1/4"	9 3/16"	N/A	N/A	18"	\$227.44		12
PER39PT4	3" X 9 3/16" X 18" Length	2 1/4"	9 3/16"	N/A	N/A	18"	\$227.44		12

See Designs At Top Of Page

Extended Span Structural Carrying Beam

PER61220ESCB	6" X 12" X Up To 20' Length	6"	12"	4"	10"	<=20'	\$2,765.94		N/A
--------------	-----------------------------	----	-----	----	-----	-------	------------	--	-----

Note: Includes Aluminum Reinforcement. Specify span length (up to 20') and tail pattern (see below) selection when ordering.

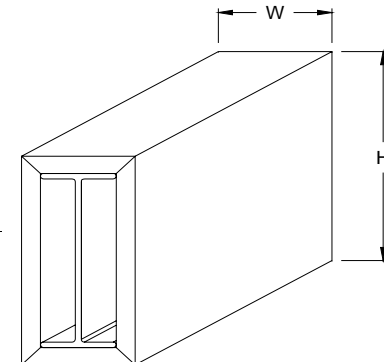

N/A



Note: Carrying Beam, Rafter and Purlin Tails are now available factory assembled. For pricing, add list price of tail(s) to list price of Beam, Rafter or Purlin and multiply by 1.1.

Tail Designs for Beams and Rafters

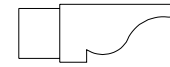

Style PT1

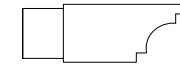

Style PT3

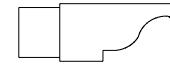

Style PT2

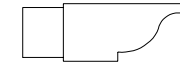

Style PT4

INTEX PERGOLA SYSTEM

Item #	Size	Outside Width 'W'	Outside Height 'H'	Inside Width 'w'	Inside Height 'h'	Length	List Price	Illustration	Full Pallet Qty
--------	------	-------------------	--------------------	------------------	-------------------	--------	------------	--------------	-----------------

Extended Span Structural Carrying Beam Decorative Tails

PER612PT1	3" X 9 3/16" X 18" Length	2 1/4"	9 3/16"	N/A	N/A	18"	\$450.94	See Designs At Top Of Page	N/A
PER612PT2	3" X 9 3/16" X 18" Length	2 1/4"	9 3/16"	N/A	N/A	18"	\$450.94		N/A
PER612PT3	3" X 9 3/16" X 18" Length	2 1/4"	9 3/16"	N/A	N/A	18"	\$450.94		N/A
PER612PT4	3" X 9 3/16" X 18" Length	2 1/4"	9 3/16"	N/A	N/A	18"	\$450.94		N/A

Note: Decorative Tails for Extended Span Carrying Beam are only sold shop installed to the beam. Prices (per Tail) include installation.

Decorative Hollow Purlin

PER2418PUR	2" X 4" X 18' Length	2"	4"	1-1/4"	3-1/4"	216"	\$280.95	See Designs At Top Of Page	N/A
------------	----------------------	----	----	--------	--------	------	----------	----------------------------	-----

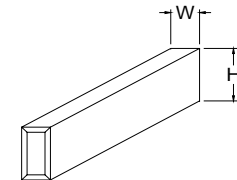

Hollow Purlin Decorative Tails

PER24PT1	2" x 4" x 7-3/4" Length	2"	4"	N/A	N/A	7-3/4"	\$123.53	See Designs At Top Of Page	N/A
PER24PT2	2" x 4" x 7-3/4" Length	2"	4"	N/A	N/A	7-3/4"	\$123.53		N/A
PER24PT3	2" x 4" x 7-3/4" Length	2"	4"	N/A	N/A	7-3/4"	\$123.53		N/A
PER24PT4	2" x 4" x 7-3/4" Length	2"	4"	N/A	N/A	7-3/4"	\$123.53		N/A



**Note: Carrying Beam, Rafter and Purlin Tails are now available factory assembled.
For pricing, add list price of tail(s) to list price of Beam, Rafter or Purlin and multiply by 1.1.**

Tail Designs for Beams and Rafters

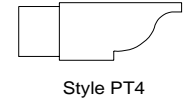
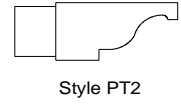
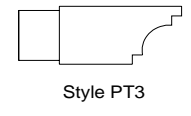
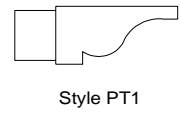

INTEX PERGOLA SYSTEM

Item #	Size	Outside Width 'W'	Outside Height 'H'	Inside Width 'w'	Inside Height 'h'	Length	List Price	Illustration	Full Pallet Qty
--------	------	-------------------	--------------------	------------------	-------------------	--------	------------	--------------	-----------------

Standard Pergola Lath

PER1218LATH	1" x 2.25" x 18' Length	2 1/4"	1"	N/A	N/A	216"	\$50.40		
-------------	-------------------------	--------	----	-----	-----	------	---------	--	--

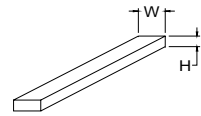

50

Pergola Rafter Aluminum Insert

PERINSERT7	1" X 6" X 16' Length	1"	6"	N/A	N/A	192"	\$213.33		
PERINSERT9	1" X 8" X 14' Length	1"	8"	N/A	N/A	168"	\$213.33		

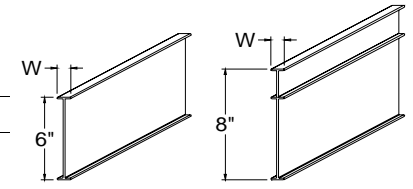

36

36

Engineered Lumber Beam Cover

PER51118SBC	5" X 11 1/4" X 18' Length	5"	11 1/4"	3 3/4"	10"	216"	\$823.84		
-------------	---------------------------	----	---------	--------	-----	------	----------	--	--

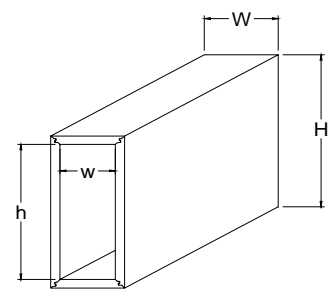

6



Note: Carrying Beam, Rafter and Purlin Tails are now available factory assembled. For pricing, add list price of tail(s) to list price of Beam, Rafter or Purlin and multiply by 1.1.

Tail Designs for Beams and Rafters

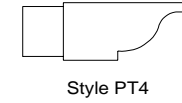
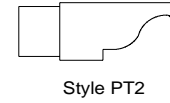
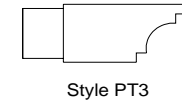
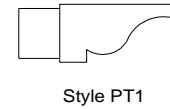

INTEX PERGOLA SYSTEM

Item #	Size	Outside Width 'W'	Outside Height 'H'	Inside Width 'w'	Inside Height 'h'	Length	List Price	Illustration	Full Pallet Qty
--------	------	-------------------	--------------------	------------------	-------------------	--------	------------	--------------	-----------------

Engineered Lumber Beam Cover Decorative Tails

PER511PT1	5" X 11 1/4" X 18"	5"	11 1/4"	N/A	N/A	18"	\$297.37	See Designs At Top Of Page	12
PER511PT2	5" X 11 1/4" X 18"	5"	11 1/4"	N/A	N/A	18"	\$297.37		12
PER511PT3	5" X 11 1/4" X 18"	5"	11 1/4"	N/A	N/A	18"	\$297.37		12
PER511PT4	5" X 11 1/4" X 18"	5"	11 1/4"	N/A	N/A	18"	\$297.37		12

Ledger Board Cover

PER21118LBC	3 3/4" X 11 1/4" X 18' Length	3 3/4"	11 1/4"	3 1/8"	10"	216"	\$519.77		12
-------------	-------------------------------	--------	---------	--------	-----	------	----------	--	----

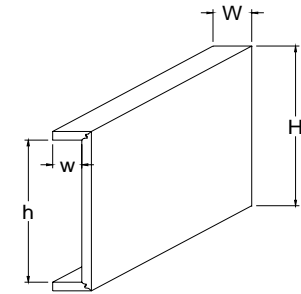

Post/Column Top Cover

PERPOST6	Top Cover for 6" Post/Column	8-3/4"	1"	N/A	N/A	N/A	\$34.92		16
PERPOST8	Top Cover for 8" Post/Column	10-3/4"	1"	N/A	N/A	N/A	\$39.96		16
PERPOST10	Top Cover for 10" Post/Column	12-3/4"	1"	N/A	N/A	N/A	\$46.05		16
PERPOST12	Top Cover for 12" Post/Column	14-3/4"	1"	N/A	N/A	N/A	\$53.17		16

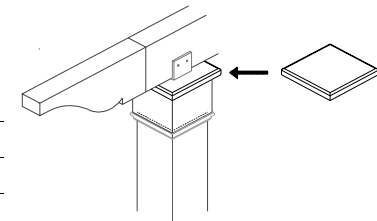



Note: Carrying Beam, Rafter and Purlin Tails are now available factory assembled. For pricing, add list price of tail(s) to list price of Beam, Rafter or Purlin and multiply by 1.1.

Tail Designs for Beams and Rafters

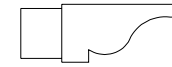

Style PT1

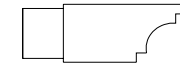

Style PT3

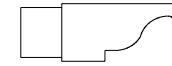

Style PT2

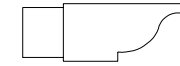

Style PT4

INTEX PERGOLA SYSTEM

Item #	Size	Outside Width 'W'	Outside Height 'H'	Inside Width 'w'	Inside Height 'h'	Length	List Price	Illustration	Full Pallet Qty
--------	------	-------------------	--------------------	------------------	-------------------	--------	------------	--------------	-----------------

Brackets & Screws

PERCBBKT	Carrying Beam Bracket	N/A	N/A	N/A	N/A	N/A	\$37.78		24
PERRABKT	Rafter Bracket	N/A	N/A	N/A	N/A	N/A	\$16.67		150
PERRAMTBKT	Ledger Board Rafter Bracket	N/A	N/A	N/A	N/A	N/A	\$47.78		50
PERESCBBKT	Extended Span Carrying Beam Mounting Bracket w/Screws	N/A	N/A	N/A	N/A	N/A	\$80.14		N/A
PER1015SCR	Bag of 150, #10 X 1.5" Stainless Self Tapping Screws (White Heads)	N/A	N/A	N/A	N/A	N/A	\$95.56		20
PERPURSCR	4-1/2" Screws for Hollow Purlin, Bag of 50 w/Bit	N/A	N/A	N/A	N/A	N/A	\$78.20		N/A
PERTB250T10	250 ml Cartridge TrimBonder 2-Part Epoxy (w/10 Applicator Tips)	N/A	N/A	N/A	N/A	N/A	\$67.86		N/A

See Our Other Literature (Or On-Line At www.intexmillwork.com) For Post Wrap Kits And Decorative Columns To Compliment The Intex Pergola System