



Marketing Materials Order Form

Ship To:	Request Date:
Attn:	Date Needed:
Address:	Distributor Order #:
City/State/Zip:	Phone#:
Distributor Acct:	

Part #	LITERATURE	Min Order	Qty Requested	Value	Marketing Support Charged
INTEXBR76P	INTEX Catalog/Brochure, 76 Page, All Products	Each	\$1.99
INTEXRS40DT	INTEX Hampton RS40 Tri-Fold Pocket Literature, 4" x 9" Pack size 50 each.	Each	\$0.20
INTEXRS60DT	INTEX Liberty RS60 Tri-Fold Pocket Literature, 4" x 9" Pack size 50 each.	Each	\$0.20
INTEXRS35DT	INTEX Dartmouth RS30 Tri-Fold Pocket Literature, 4" x 9" Pack size 50 each.	Each	\$0.20
INTEXSHUTBRO	INTEX Shutter Brochure 11" x 17"	Each	\$0.24
SHUTTERSWATCH	INTEX Shutter Paint Color Swatch	Each	\$0.95
INTEXOLC	INTEX Outdoor Living Catalog, Including Fence, Shower Enclosure, Pergola	Each	\$1.32
SLEEVE SAMPLES					
EASYSAMP	Easy-Wrap Column Sample w/Graphic, 4-1/2" Sq x 6-1/2".	Each	\$18.20
EASYSAMP-KD	Knocked Down Easy-Wrap Column Sample, 4-1/2" Sq x 6-1/2".	Each	\$18.20
EASYWRAPDISP	Easy-Wrap Counter Display, 4-1/2" SQ & 6-1/2" SQ, Graphics, 75 Bed Trim, Brown Painted Base	Each	\$85.62
NRE-NRASAMP	INTEX Newel Sample 8" x 24" with Recessed & Raised Panels, Flat, with Base Wrap & WM164 Trim	Each	\$43.20
SQCOLSAMP	6" SQ x 18" Column Wrap Sample- Multi Faced, with 2" Cap and 6" Base Wrap & 164BC Trim	Each	\$80.19
TCOLSAMP	Square Tapered Column Sample Multi faced, 5/8" Wall, 8" to 6" Taper, 18" Tall, with WM75 Cap and Base Trim, 5/8" Thick Cap and Base Plates	Each	\$90.65
COLUMNDISP	Column wrap counter display, Multi design faces. Tapered and Square, with lit holder and flyers	Each	\$209.33
PERGOLA SAMPLES/DISPLAYS					
EPR7SAMPLE	Engineered Pergola 7" Rafter Sample, w/PT1 Tail and Aluminum Reinforcement	Each	\$46.66
EPR9SAMPLE	Engineered Pergola 9" Rafter Sample, w/PT1 Tail and Aluminum Reinforcement	Each	\$47.06
EPR5SAMPLE	Classic Kit Pergola 5" Rafter Sample, with PT1 Tail and Aluminum Reinforcement	Each	\$38.53
PERGDISP	INTEX Pergola Rafter Display, Rafter Variations with PT1 Tails on 8" Recessed Column with INC004 Inlays	Each	\$311.04
CCTAILSAMP-HOLLOW	Hollow Soffit Tail Sample, 3" Thick, 7" Tall, 24" Long, PT1 Tail 1 End. Edges Sanded/Painted	Each	\$61.17
GUTTER SAMPLES/DISPLAYS					
GUTTERSAMP	Boston PVC Gutter Sample, 4" Length, with Label, Includes Bracket Mounting Components	Each	\$9.37

RAILING MINI SAMPLES

RS10600SAMP	RS10600 Rail Cut 6", Top and Bottom Section and Reinforcement	Each	\$21.35
RS20500SAMP	RS20500 Rail Cut 6", Top and Bottom Section and Reinforcement Plus Optional Wood cap	Each	\$20.31
RS20700SAMP	RS20700 Rail Cut 6" Top and Bottom Sections with Reinforcement	Each	\$28.26
RS20800SAMP	RS20800 Rail Cut 6" Top and Bottom Sections with Reinforcement	Each	\$31.25
RS35MS350	Dartmouth 3-1/2" Top, Bottom Rail & Reinforcement, + Baluster & Bracket	Each	\$13.88
RS35MS400	Dartmouth 4" Top, Bottom Rail & Reinforcement, + Baluster & Bracket	Each	\$13.96
RS40MSFT	Hampton Flat Top, Bottom Rail & Reinforcement, + Baluster & Bracket	Each	\$10.88
RS40MSFT-M	Hampton Flat Mahogany Top, Bottom Rail & Reinforcement, + Baluster & Bracket	Each	\$11.44
RS40MSPT	Hampton Peaked Top, Bottom Rail & Reinforcement, + Baluster & Bracket	Each	\$10.88
RS40MSPT-M	Hampton Peaked Mahogany Top, Bottom Rail & Reinforcement, + Baluster & Bracket	Each	\$12.99
RS50500SAMP	Nautilus RS50500 5" Top Cap Rail 6" Sample, Top & Baluster Cap, Bottom Rail, + Reinforcement	Each	\$23.15
RS50SAMPLE	RS50 5" Gooseneck Rail Sample, 36" Section, Top Rail Only, with Reinforcement, Prime Coat Applied	Each	\$140.53
RS60MS275	Liberty 2-3/4" Graspable Top, Bottom Rail & Reinforcement, + Baluster & Bracket	Each	\$11.19
RS60MS350	Liberty 3-1/2" Top, Bottom Rail & Reinforcement, + Baluster & Bracket	Each	\$11.33
RS60STAIRSAMP	RS60 Salesman Stair Sample, Routed Common Rails, with (2) Short Stair Balusters	Each	\$23.49

RAILING FLOOR/COUNTER DISPLAYS

RS40RAILDISP	Display, RS40 Hampton Rail, Include Flat & Peak Rail with 5" Newel Cover & Plain Cap, Includes Graphics and Literature	Each	\$282.59
RS35RAILDISP	Display, RS30 Rail System, Include RS30350 and RS30400 with 5" Newel Cover & Plain Cap, Includes Graphics and Literature	Each	\$311.92
RS60RAILDISP	Display, RS60 Liberty Series, Include 3-1/2" and 2-3/4" (Graspable) Section, with 5" Newel, Molded Base Trim and Flat Cap. Includes Graphics and Literature	Each	\$313.96

SHUTTER SAMPLES

SHUTTERSAMP-01	15"x30" Louver Shutter Sample Prefinished Black with Graphics & Color Swatch	Each	\$87.00
SHUTTERSAMP-02	15"x30" Panel Shutter Sample Prefinished Black with Graphics & Color Swatch	Each	\$90.00

FENCE SAMPLES

FS10-DS-01	FS10 Estate Countertop Display	Each	\$130.00
FS10-DS-02	FS20 Estate Countertop Display	Each	N/A

WINDOW SURROUND SAMPLE

SURSAMPLEHALF	Salesman Sample, Half Surround, with WM52 Crown and 311 Sill on Apron, 5/4 x 4 with J-Channel	Each	\$34.66
---------------	---	------	-------	---------	-------

UPS/Freight Costs.....

Total Cost Charged to Marketing Support Fund.....

Marketing Materials, Samples and Showroom Displays

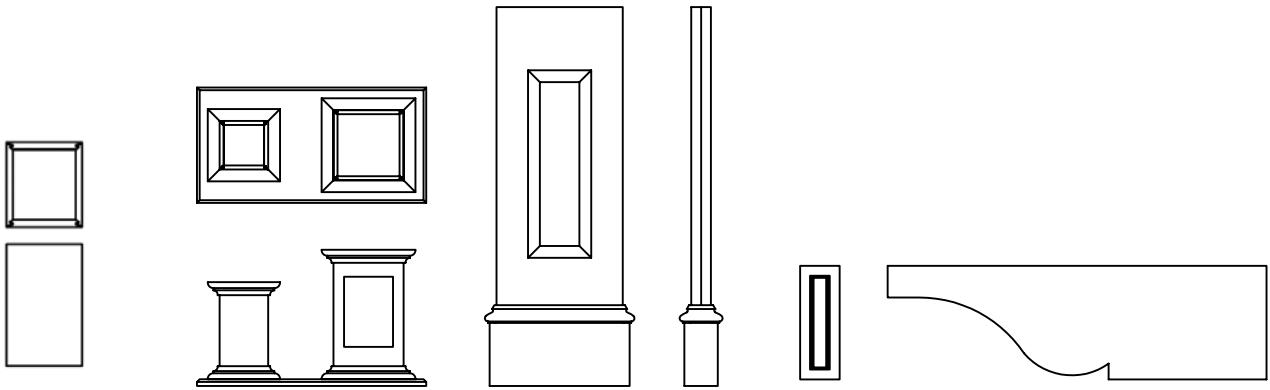

EASYSAMP

EASYWRAPDISP

NRE-NRASAMP

EPR7SAMPLE
EPR9SAMPLE

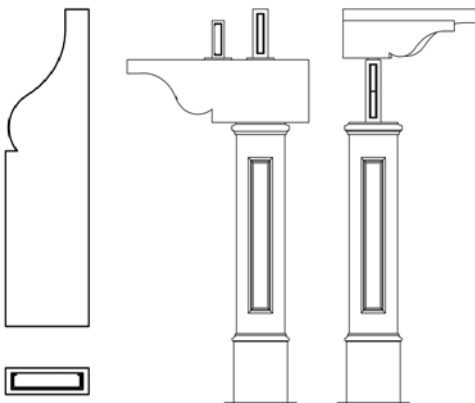

PKR5SAMPLE

PERGDISP



GUTTERSAMP



RS10600SAMP

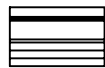

RS20500SAMP

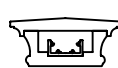
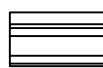

RS20700SAMP

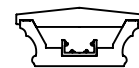
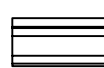

RS20800SAMP

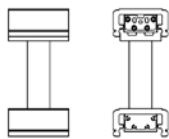
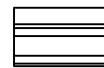

RS35MS350

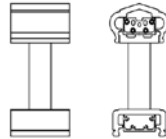

RS35MS400

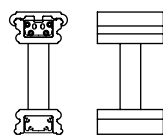

RS40MSFT
RS40MSFT-M
Mahogany Top

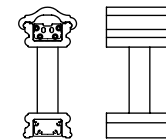

RS40MSPT



INTEX[®]
MILLWORK SOLUTIONS

Marketing Materials, Samples and Showroom Displays

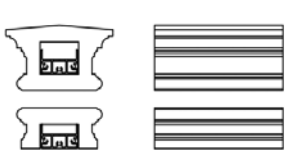

RS50500SAMP

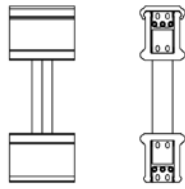

RS60MS275

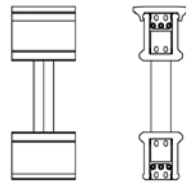

RS60MS350

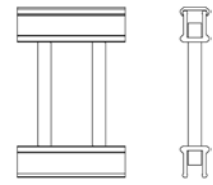

RS60STAIRSAMP

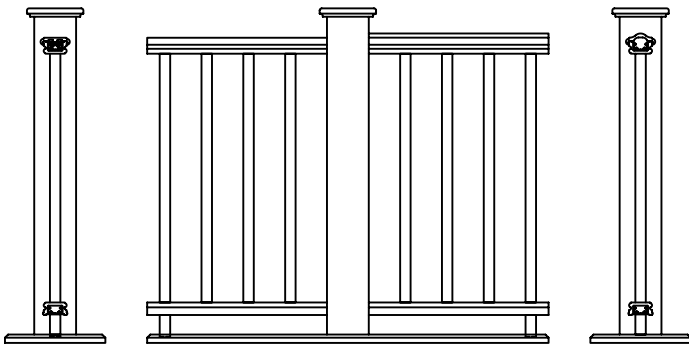

RS40RAILDISP

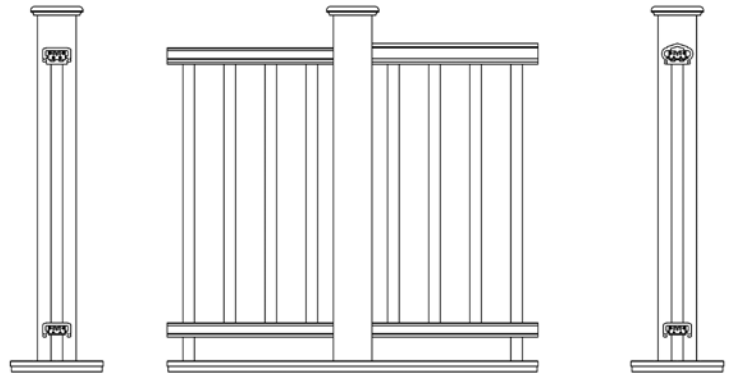

RS35RAILDISP

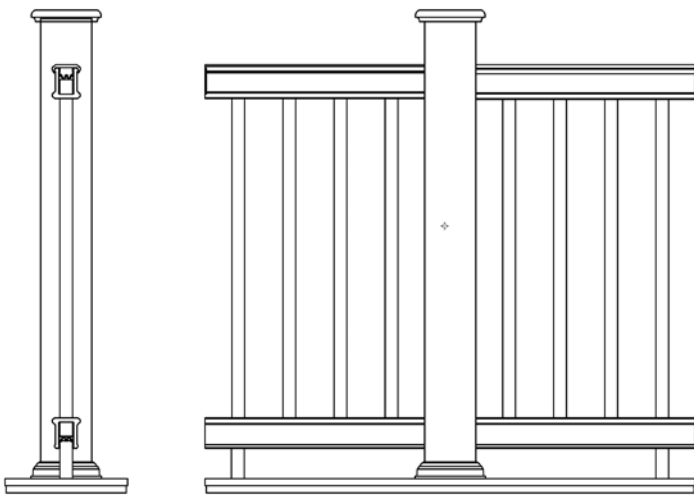

RS60RAILDISP

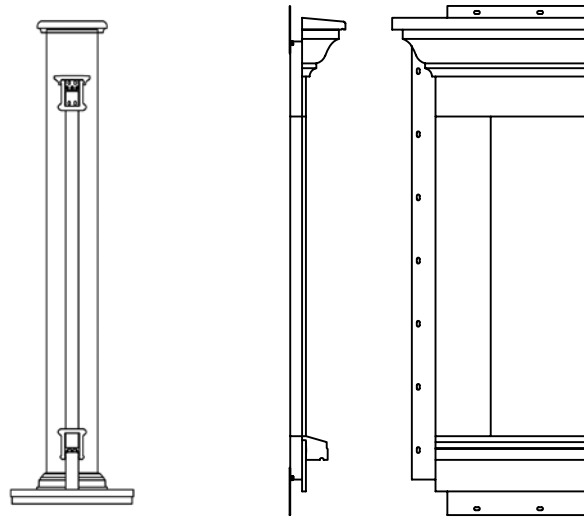

SURSAMPLEHALF



RS50SAMPLE

Marketing Materials, Samples and Showroom Displays

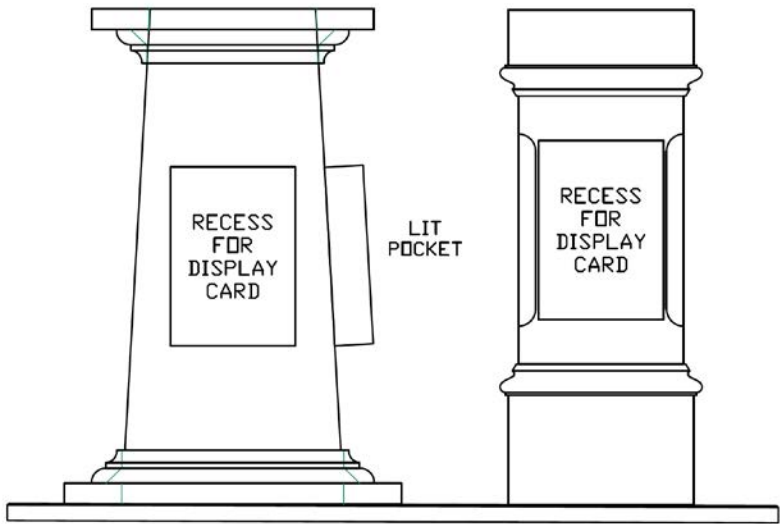

COLUMNDISP

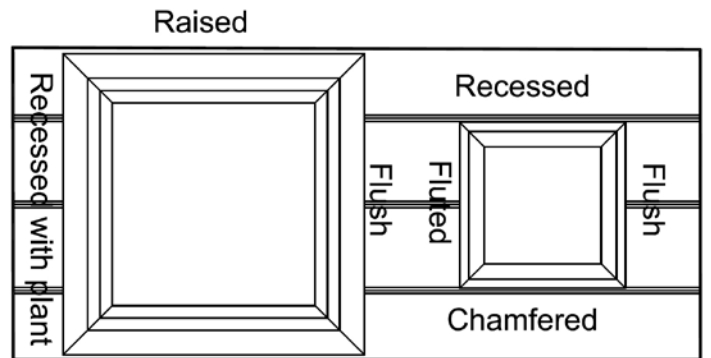

Flush with card

COLUMNDISP - Top View

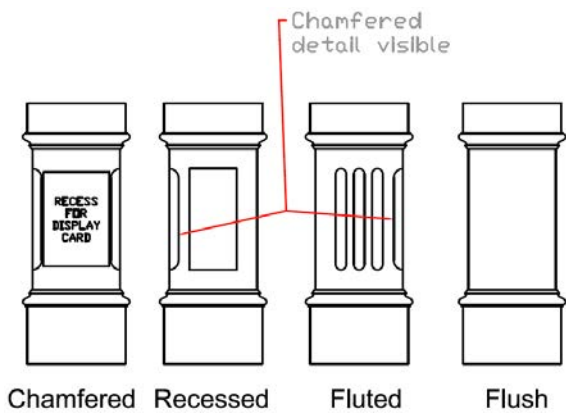

Chamfered Recessed Fluted Flush

SQCOLSAMP

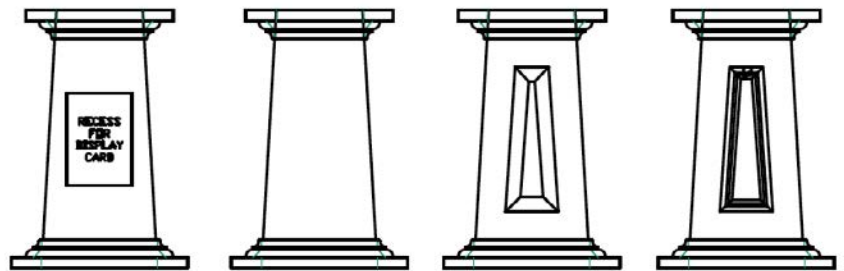

Flush Flush Raised Recessed with plant

TCOLSAMP



INTEX[®]
MILLWORK SOLUTIONS