



# Marketing Materials Order Form

Ship To: .....	Request Date: .....
Attn: .....	Date Needed: .....
Address: .....	Distributor Order #: .....
City/State/Zip: .....	Phone#: .....
Distributor Acct: .....	

Part #		Min Order	Qty Requested	Value	Marketing Support Charged
<b>LITERATURE</b>					
INTEXBR76P	INTEX Catalog/Brochure, 76 Page, All Products, Pack size 20 each.	Each	.....	\$1.99	.....
INTEXRS40DT	INTEX Hampton RS40 Tri-Fold Pocket Literature, 4" x 9" Pack size 50 each.	Each	.....	\$0.20	.....
INTEXRS60DT	INTEX Liberty RS60 Tri-Fold Pocket Literature, 4" x 9" Pack size 50 each.	Each	.....	\$0.20	.....
INTEXRS35DT	INTEX Dartmouth RS30 Tri-Fold Pocket Literature, 4" x 9" Pack size 50 each.	Each	.....	\$0.20	.....
INTEXSHUTBRO	INTEX Shutter Brochure 11" x 17"	Each	.....	\$0.24	.....
SHUTTERSWATCH	INTEX Shutter Paint Color Swatch	Each	.....	\$0.95	.....
INTEXOLC	INTEX Outdoor Living Catalog, Including Fence, Shower Enclosure, Pergola	Each	.....	\$1.32	.....
<b>SLEEVE SAMPLES</b>					
EASYSAMP	Easy-Wrap Column Sample w/Graphic, 4-1/2" Sq x 6-1/2".	Each	.....	\$18.20	.....
EASYSAMP-KD	Knocked Down Easy-Wrap Column Sample, 4-1/2" Sq x 6-1/2".	Each	.....	\$18.20	.....
EASYWRAPDISP	Easy-Wrap Counter Display, 4-1/2" SQ & 6-1/2" SQ, Graphics, 75 Bed Trim, Brown Painted Base	Each	.....	\$85.62	.....
NRE-NRASAMP	INTEX Newel Sample 8" x 24" with Recessed & Raised Panels, Flat, with Base Wrap & WM164 Trim	Each	.....	\$43.20	.....
SQCOLSAMP	6" SQ x 18" Column Wrap Sample- Multi Faced, with 2" Cap and 6" Base Wrap & 164BC Trim	Each	.....	\$80.19	.....
TCOLSAMP	Square Tapered Column Sample Multi faced, 5/8" Wall, 8" to 6" Taper, 18" Tall, with WM75 Cap and Base Trim, 5/8" Thick Cap and Base Plates	Each	.....	\$90.65	.....
COLUMNDISP	Column wrap counter display, Multi design faces. Tapered and Square, with lit holder and flyers	Each	.....	\$209.33	.....
<b>PERGOLA SAMPLES/DISPLAYS</b>					
EPR7SAMPLE	Engineered Pergola 7" Rafter Sample, w/PT1 Tail and Aluminum Reinforcement	Each	.....	\$46.66	.....
EPR9SAMPLE	Engineered Pergola 9" Rafter Sample, w/PT1 Tail and Aluminum Reinforcement	Each	.....	\$47.06	.....
EPR5SAMPLE	Classic Kit Pergola 5" Rafter Sample, with PT1 Tail and Aluminum Reinforcement	Each	.....	\$38.53	.....
PERGDISP	INTEX Pergola Rafter Display, Rafter Variations with PT1 Tails on 8" Recessed Column with INC004 Inlays	Each	.....	\$311.04	.....
CCTAILSAMP-HOLLOW	Hollow Soffit Tail Sample, 3" Thick, 7" Tall, 24" Long, PT1 Tail 1 End. Edges Sanded/Painted	Each	.....	\$61.17	.....
<b>GUTTER SAMPLES/DISPLAYS</b>					
GUTTERSAMP	Boston PVC Gutter Sample, 4" Length, with Label, Includes Bracket Mounting Components	Each	.....	\$9.37	.....

**RAILING MINI SAMPLES**

RS10600SAMP	RS10600 Rail Cut 6", Top and Bottom Section and Reinforcement	Each	.....	\$21.35	.....
RS20500SAMP	RS20500 Rail Cut 6", Top and Bottom Section and Reinforcement Plus Optional Wood cap	Each	.....	\$20.31	.....
RS20700SAMP	RS20700 Rail Cut 6" Top and Bottom Sections with Reinforcement	Each	.....	\$28.26	.....
RS20800SAMP	RS20800 Rail Cut 6" Top and Bottom Sections with Reinforcement	Each	.....	\$31.25	.....
RS35MS350	Dartmouth 3-1/2" Top, Bottom Rail & Reinforcement, + Baluster & Bracket	Each	.....	\$13.88	.....
RS35MS400	Dartmouth 4" Top, Bottom Rail & Reinforcement, + Baluster & Bracket	Each	.....	\$13.96	.....
RS40MSFT	Hampton Flat Top, Bottom Rail & Reinforcement, + Baluster & Bracket	Each	.....	\$10.88	.....
RS40MSFT-M	Hampton Flat Mahogany Top, Bottom Rail & Reinforcement, + Baluster & Bracket	Each	.....	\$11.44	.....
RS40MSPT	Hampton Peaked Top, Bottom Rail & Reinforcement, + Baluster & Bracket	Each	.....	\$10.88	.....
RS40MSPT-M	Hampton Peaked Mahogany Top, Bottom Rail & Reinforcement, + Baluster & Bracket	Each	.....	\$12.99	.....
RS50500SAMP	Nautilus RS50500 5" Top Cap Rail 6" Sample, Top & Baluster Cap, Bottom Rail, + Reinforcement	Each	.....	\$23.15	.....
RS50SAMPLE	RS50 5" Gooseneck Rail Sample, 36" Section, Top Rail Only, with Reinforcement, Prime Coat Applied	Each	.....	\$140.53	.....
RS60MS275	Liberty 2-3/4" Graspable Top, Bottom Rail & Reinforcement, + Baluster & Bracket	Each	.....	\$11.19	.....
RS60MS350	Liberty 3-1/2" Top, Bottom Rail & Reinforcement, + Baluster & Bracket	Each	.....	\$11.33	.....
RS60STAIRSAMP	RS60 Salesman Stair Sample, Routed Common Rails, with (2) Short Stair Balusters	Each	.....	\$23.49	.....

**RAILING FLOOR/COUNTER DISPLAYS**

RS40RAILDISP	Display, RS40 Hampton Rail, Include Flat & Peak Rail with 5" Newel Cover & Plain Cap, Includes Graphics and Literature	Each	.....	\$282.59	.....
RS35RAILDISP	Display, RS30 Rail System, Include RS30350 and RS30400 with 5" Newel Cover & Plain Cap, Includes Graphics and Literature	Each	.....	\$311.92	.....
RS60RAILDISP	Display, RS60 Liberty Series, Include 3-1/2" and 2-3/4" (Graspable) Section, with 5" Newel, Molded Base Trim and Flat Cap. Includes Graphics and Literature	Each	.....	\$313.96	.....

**SHUTTER SAMPLES**

SHUTTERSAMP-01	15"x30" Louver Shutter Sample Prefinished Black with Graphics & Color Swatch	Each	.....	\$87.00	.....
SHUTTERSAMP-02	15"x30" Panel Shutter Sample Prefinished Black with Graphics & Color Swatch	Each	.....	\$90.00	.....

**FENCE SAMPLES**

FS10-DS-01	FS10 Estate Countertop Display	Each	.....	\$130.00	.....
FS10-DS-02	FS20 Estate Countertop Display	Each	.....	N/A	.....

**WINDOW SURROUND SAMPLE**

SURSAMPLEHALF	Salesman Sample, Half Surround, with WM52 Crown and 311 Sill on Apron, 5/4 x 4 with J-Channel	Each	.....	\$34.66	.....
---------------	---	------	-------	---------	-------

UPS/Freight Costs.....

Total Cost Charged to Marketing Support Fund.....

# Marketing Materials, Samples and Showroom Displays

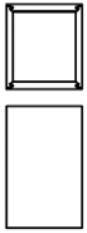

EASYSAMP

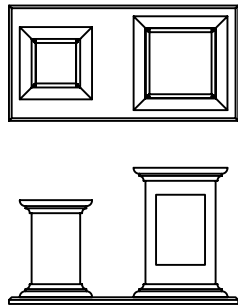

EASYWRAPDISP

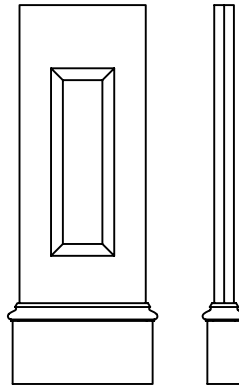

NRE-NRASAMP

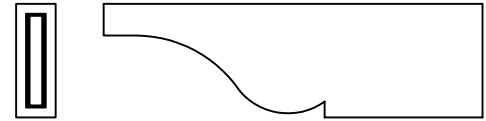

EPR7SAMPLE  
EPR9SAMPLE



PKR5SAMPLE

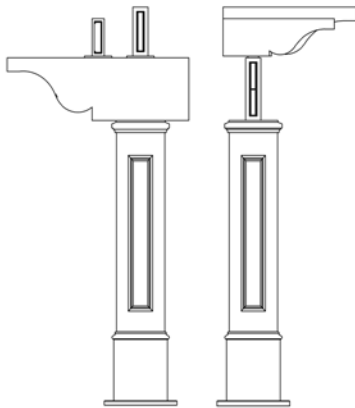

PERGDISP

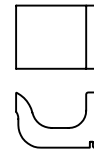

GUTTERSAMP



RS10600SAMP

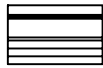

RS20500SAMP

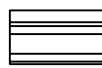

RS20700SAMP

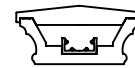
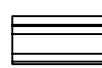

RS20800SAMP

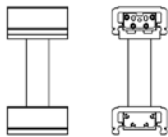

RS35MS350

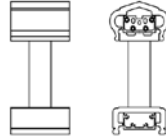

RS35MS400

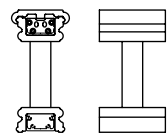

RS40MSFT  
RS40MSFT-M

Mahogany Top

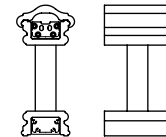

RS40MSPT



**INTEX**<sup>®</sup>  
MILLWORK SOLUTIONS

# Marketing Materials, Samples and Showroom Displays

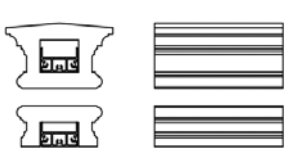

RS50500SAMP

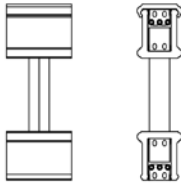

RS60MS275

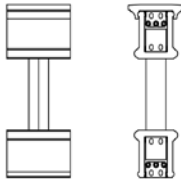

RS60MS350

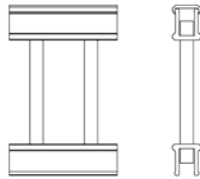

RS60STAIRSAMP

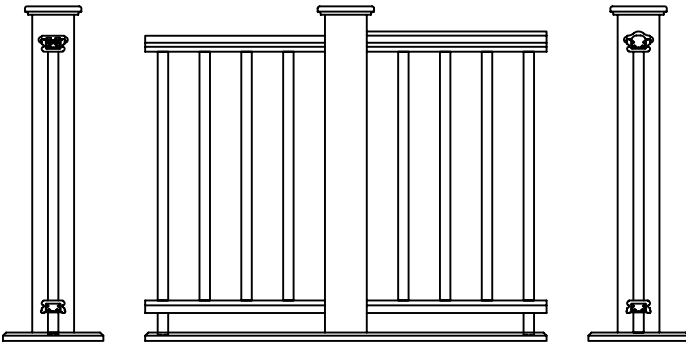

RS40RAILDISP

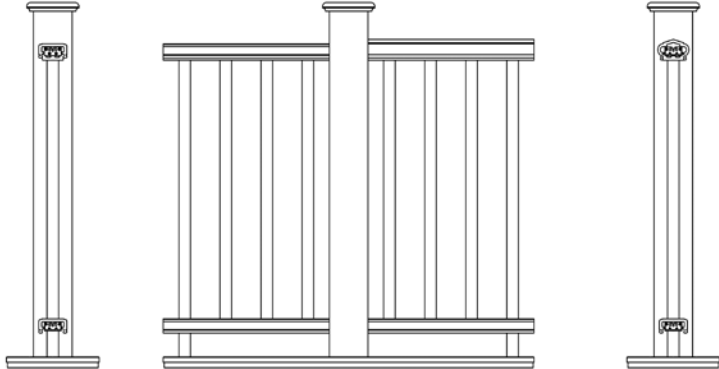

RS35RAILDISP



RS60RAILDISP

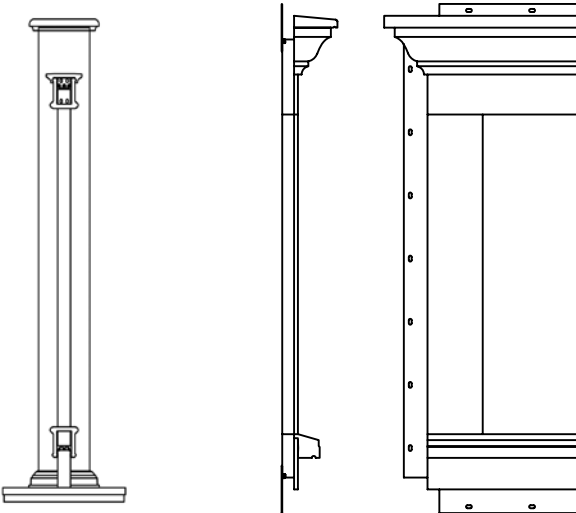

SURSAMPLEHALF



RS50SAMPLE

# Marketing Materials, Samples and Showroom Displays

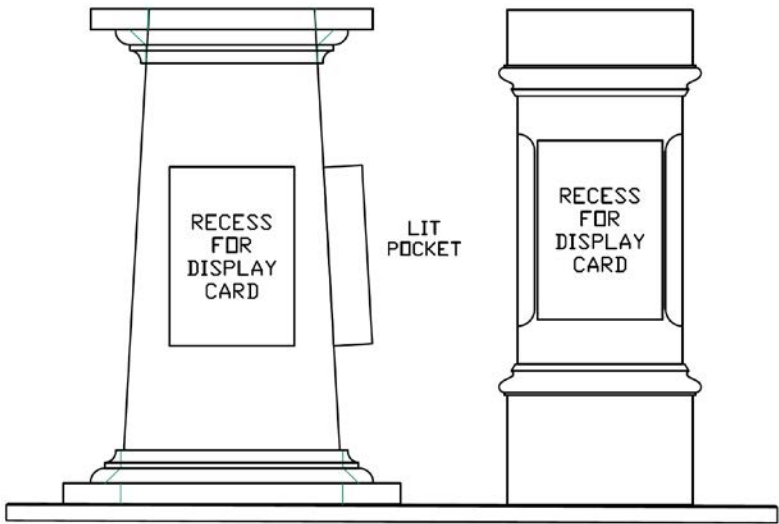

COLUMNDISP

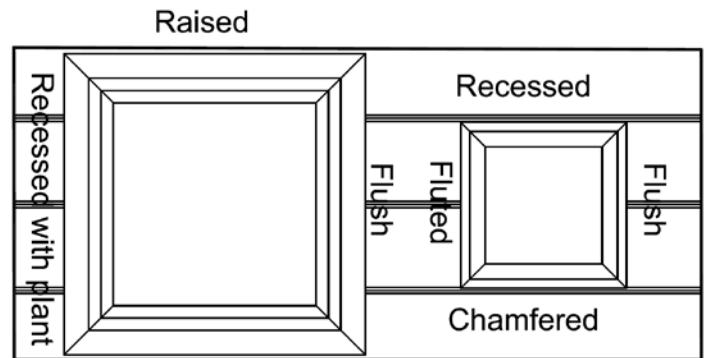

Flush with card

COLUMNDISP - Top View

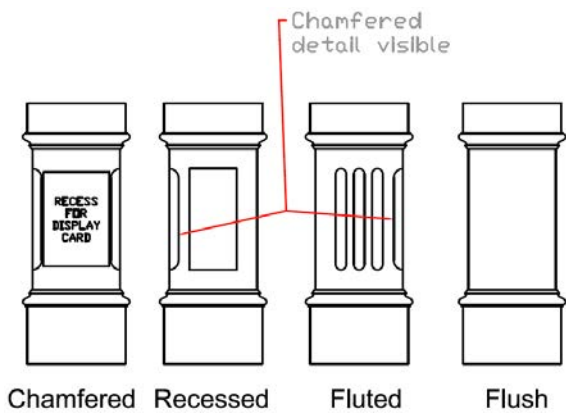

Chamfered Recessed Fluted Flush

SQCOLSAMP

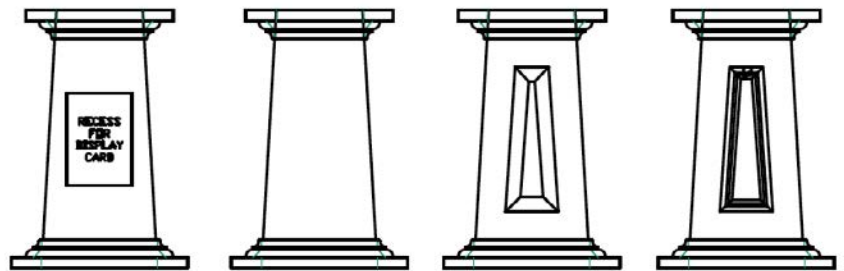

Flush Flush Raised Recessed with plant

TCOLSAMP



**INTEX**<sup>®</sup>  
MILLWORK SOLUTIONS