



INTEX[®]
MILLWORK SOLUTIONS

2

1

B

B

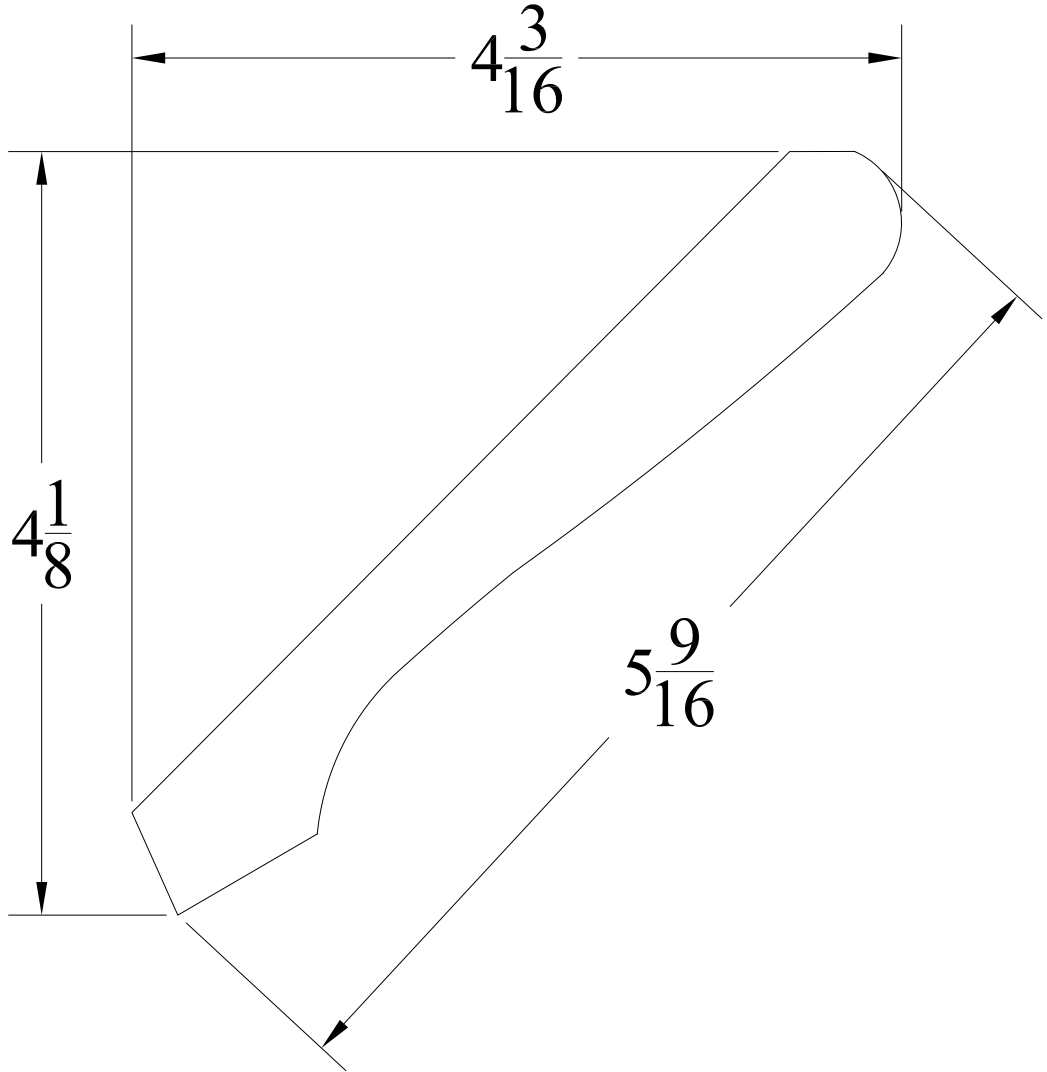

NOTE: A SHORT RUN SETUP CHARGE APPLIES TO ORDERS OF LESS THAN 20 PIECES

A

A

MATERIAL	CELLULAR PVC	NAME	DATE	DESCRIPTION
FINISH	MATTE WHITE	DRAWN	XXX XX-XX-XXXX	
LENGTH	17' 6"	CHECKED	XXX XX-XX-XXXX	
INTEX MILLWORK SOLUTIONS 45 MILL STREET MAYS LANDING, NJ 08330 PHONE: (856) 293-4100 FAX: (856) 293-4102	COMMENTS:			
SIZE	DWG. NO.	ICM127		
A				SHEET 1 OF 1

2

1