

Cellular PVC Newel Covers and Accessories

Item #	Description	List Price	Optional Plant Pricing (If Applicable)	
Plain Panel Newels				Optional Applied 'Plant' Trim, 4 sides
NP640	6" Sq X 40" Newel Cover, Plain Flat Sides W/9" Wrap & WM164 Base Trim (I.D. is 4-3/4", does not fit a PT6X6)	\$218.01	\$111.86	
NP646	6" Sq X 46" Newel Cover, Plain Flat Sides W/9" Wrap & WM164 Base Trim (I.D. is 4-3/4", does not fit a PT6X6)	\$235.64	\$114.31	
NP650	6" Sq X 50" Newel Cover, Plain Flat Sides W/17" Wrap & WM164 Base Trim (I.D. is 4-3/4", does not fit a PT6X6)	\$261.98	\$115.93	
NP840	8" Sq X 40" Newel Cover, Plain Flat Sides W/9" Wrap & WM164 Base Trim	\$244.98	\$112.68	
NP846	8" Sq X 46" Newel Cover, Plain Flat Sides W/9" Wrap & WM164 Base Trim	\$278.07	\$115.12	
NP850	8" Sq X 50" Newel Cover, Plain Flat Sides W/17" Wrap & WM164 Base Trim	\$311.19	\$116.75	
NP1040	10" Sq X 40" Newel Cover, Plain Flat Sides W/9" Wrap & WM164 Base Trim	\$287.11	\$113.49	
NP1046	10" Sq X 46" Newel Cover, Plain Flat Sides W/9" Wrap & WM164 Base Trim	\$320.50	\$115.93	
NP1050	10" Sq X 50" Newel Cover, Plain Flat Sides W/17" Wrap & WM164 Base Trim	\$375.46	\$117.56	
NP1240	12" Sq X 40" Newel Cover, Plain Flat Sides W/9" Wrap & WM164 Base Trim	\$324.68	\$114.31	
NP1246	12" Sq X 46" Newel Cover, Plain Flat Sides W/9" Wrap & WM164 Base Trim	\$353.90	\$116.75	
NP1250	12" Sq X 50" Newel Cover, Plain Flat Sides W/17" Wrap & WM164 Base Trim	\$394.53	\$118.37	
NP640-38	6" Sq X 40" Newel Cover, Plain Flat Sides (3/8" Wall) W/9" Wrap & WM164 Base Trim (I.D. is 5-1/4", does not fit a PT6X6)	\$189.09	N/A	
NP646-38	6" Sq X 46" Newel Cover, Plain Flat Sides (3/8" Wall) W/9" Wrap & WM164 Base Trim (I.D. is 5-1/4", does not fit a PT6X6)	\$202.37	N/A	
NP650-38	6" Sq X 50" Newel Cover, Plain Flat Sides (3/8" Wall) W/17" Wrap & WM164 Base Trim (I.D. is 5-1/4", does not fit a PT6X6)	\$225.82	N/A	
NP840-38	8" Sq X 40" Newel Cover, Plain Flat Sides (3/8" Wall) W/9" Wrap & WM164 Base Trim	\$217.01	N/A	
NP846-38	8" Sq X 46" Newel Cover, Plain Flat Sides (3/8" Wall) W/9" Wrap & WM164 Base Trim	\$233.72	N/A	
NP850-38	8" Sq X 50" Newel Cover, Plain Flat Sides (3/8" Wall) W/17" Wrap & WM164 Base Trim	\$262.97	N/A	
NP1040-38	10" Sq X 40" Newel Cover, Plain Flat Sides (3/8" Wall) W/9" Wrap & WM164 Base Trim	\$244.93	N/A	
NP1046-38	10" Sq X 46" Newel Cover, Plain Flat Sides (3/8" Wall) W/9" Wrap & WM164 Base Trim	\$265.06	N/A	
NP1050-38	10" Sq X 50" Newel Cover, Plain Flat Sides (3/8" Wall) W/17" Wrap & WM164 Base Trim	\$300.13	N/A	
NP1240-38	12" Sq X 40" Newel Cover, Plain Flat Sides (3/8" Wall) W/9" Wrap & WM164 Base Trim	\$272.85	N/A	
NP1246-38	12" Sq X 46" Newel Cover, Plain Flat Sides (3/8" Wall) W/9" Wrap & WM164 Base Trim	\$296.41	N/A	
NP1250-38	12" Sq X 50" Newel Cover, Plain Flat Sides (3/8" Wall) W/17" Wrap & WM164 Base Trim	\$337.28	N/A	

Cellular PVC Newel Covers and Accessories

Item #	Description	List Price	Optional Plant Pricing (If Applicable)	
--------	-------------	------------	--	--

Recessed Panel Newels

Item #	Description	List Price	Optional Plant Pricing (If Applicable)	Optional Applied 'Plant' Trim, (in Recessed Panels)
NRE640	6" Sq X 40" Newel Cover, Recessed Panel Four Sides W/9" Wrap & WM164 Base Trim (I.D. is 4", does not fit a PT6X6)	\$287.20	\$111.86	
NRE640L	6" Sq X 40" Newel Cover, Recessed Panel Two Sides -Line W/9" Wrap & WM164 Base Trim (I.D. is 4" X 4-3/4", does not fit a PT6X6)	\$279.77	\$61.02	
NRE640C	6" Sq X 40" Newel Cover, Recessed Panel 2 Sides -Corner W/9" Wrap & WM164 Base Trim (I.D. is 4-3/8" X 4-3/8", does not fit a PT6X6)	\$270.73	\$61.02	
NRE640E	6" Sq X 40" Newel Cover, Recessed Panel 3 Sides -End W/9" Wrap & WM164 Base Trim (I.D. is 4" x 4-3/8", does not fit a PT6X6)	\$296.31	\$86.44	
NRE646	6" Sq X 46" Newel Cover, Recessed Panel Four Sides W/9" Wrap & WM164 Base Trim (I.D. is 4", does not fit a PT6X6)	\$313.12	\$114.31	
NRE646L	6" Sq X 46" Newel Cover, Recessed Panel Two Sides -Line W/9" Wrap & WM164 Base Trim (I.D. is 4" X 4-3/4", does not fit a PT6X6)	\$297.03	\$63.46	
NRE646C	6" Sq X 46" Newel Cover, Recessed Panel 2 Sides -Corner W/9" Wrap & WM164 Base Trim (I.D. is 4-3/8" X 4-3/8", does not fit a PT6X6)	\$287.99	\$63.46	
NRE646E	6" Sq X 46" Newel Cover, Recessed Panel 3 Sides -End W/9" Wrap & WM164 Base Trim (I.D. is 4" x 4-3/8", does not fit a PT6X6)	\$314.89	\$88.88	
NRE650	6" Sq X 50" Newel Cover, Recessed Panel Four Sides W/17" Wrap & WM164 Base Trim (I.D. is 4", does not fit a PT6X6)	\$346.00	\$115.93	
NRE650L	6" Sq X 50" Newel Cover, Recessed Panel Two Sides -Line W/17" Wrap & WM164 Base Trim (I.D. is 4" X 4-3/4", does not fit a PT6X6)	\$319.10	\$65.08	
NRE650C	6" Sq X 50" Newel Cover, Recessed Panel 2 Sides -Corner W/17" Wrap & WM164 Base Trim (I.D. is 4-3/8" X 4-3/8", does not fit a PT6X6)	\$310.07	\$65.08	
NRE650E	6" Sq X 50" Newel Cover, Recessed Panel 3 Sides -End W/17" Wrap & WM164 Base Trim (I.D. is 4" x 4-3/8", does not fit a PT6X6)	\$337.85	\$90.51	
NRE840	8" Sq X 40" Newel Cover, Recessed Panel Four Sides W/9" Wrap & WM164 Base Trim	\$333.65	\$112.68	
NRE840L	8" Sq X 40" Newel Cover, Recessed Panel Two Sides -Line W/9" Wrap & WM164 Base Trim	\$323.28	\$61.83	
NRE840C	8" Sq X 40" Newel Cover, Recessed Panel 2 Sides -Corner W/9" Wrap & WM164 Base Trim	\$314.24	\$61.83	
NRE840E	8" Sq X 40" Newel Cover, Recessed Panel 3 Sides -End W/9" Wrap & WM164 Base Trim	\$342.80	\$87.25	
NRE846	8" Sq X 46" Newel Cover, Recessed Panel Four Sides W/9" Wrap & WM164 Base Trim	\$370.10	\$115.12	
NRE846L	8" Sq X 46" Newel Cover, Recessed Panel Two Sides -Line W/9" Wrap & WM164 Base Trim	\$346.73	\$64.27	
NRE846C	8" Sq X 46" Newel Cover, Recessed Panel 2 Sides -Corner W/9" Wrap & WM164 Base Trim	\$337.69	\$64.27	
NRE846E	8" Sq X 46" Newel Cover, Recessed Panel 3 Sides -End W/9" Wrap & WM164 Base Trim	\$368.23	\$89.69	
NRE850	8" Sq X 50" Newel Cover, Recessed Panel Four Sides W/17" Wrap & WM164 Base Trim	\$411.51	\$116.75	
NRE850L	8" Sq X 50" Newel Cover, Recessed Panel Two Sides -Line W/17" Wrap & WM164 Base Trim	\$376.46	\$65.90	
NRE850C	8" Sq X 50" Newel Cover, Recessed Panel 2 Sides -Corner W/17" Wrap & WM164 Base Trim	\$367.42	\$65.90	
NRE850E	8" Sq X 50" Newel Cover, Recessed Panel 3 Sides -End W/17" Wrap & WM164 Base Trim	\$399.28	\$91.32	

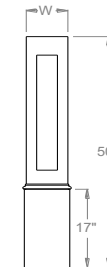
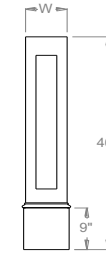
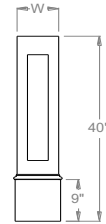

Cellular PVC Newel Covers and Accessories

Item #	Description	List Price	Optional Plant Pricing (If Applicable)	
--------	-------------	------------	--	--

Recessed Panel Newels (Continued)

Optional Applied
'Plant' Trim, (in
Recessed Panels)

NRE1040	10" Sq X 40" Newel Cover, Recessed Panel Four Sides W/9" Wrap & WM164 Base Trim	\$377.08	\$113.49
NRE1040L	10" Sq X 40" Newel Cover, Recessed Panel Two Sides -Line W/9" Wrap & WM164 Base Trim	\$366.80	\$62.64
NRE1040C	10" Sq X 40" Newel Cover, Recessed Panel 2 Sides -Comer W/9" Wrap & WM164 Base Trim	\$357.76	\$62.64
NRE1040E	10" Sq X 40" Newel Cover, Recessed Panel 3 Sides -End W/9" Wrap & WM164 Base Trim	\$389.29	\$88.07
NRE1046	10" Sq X 46" Newel Cover, Recessed Panel Four Sides W/9" Wrap & WM164 Base Trim	\$421.05	\$115.93
NRE1046L	10" Sq X 46" Newel Cover, Recessed Panel Two Sides -Line W/9" Wrap & WM164 Base Trim	\$396.43	\$65.08
NRE1046C	10" Sq X 46" Newel Cover, Recessed Panel 2 Sides -Comer W/9" Wrap & WM164 Base Trim	\$387.39	\$65.08
NRE1046E	10" Sq X 46" Newel Cover, Recessed Panel 3 Sides -End W/9" Wrap & WM164 Base Trim	\$421.57	\$90.51
NRE1050	10" Sq X 50" Newel Cover, Recessed Panel Four Sides W/17" Wrap & WM164 Base Trim	\$474.01	\$117.56
NRE1050L	10" Sq X 50" Newel Cover, Recessed Panel Two Sides -Line W/17" Wrap & WM164 Base Trim	\$433.82	\$66.71
NRE1050C	10" Sq X 50" Newel Cover, Recessed Panel 2 Sides -Comer W/17" Wrap & WM164 Base Trim	\$424.78	\$66.71
NRE1050E	10" Sq X 50" Newel Cover, Recessed Panel 3 Sides -End W/17" Wrap & WM164 Base Trim	\$460.72	\$92.14
NRE1240	12" Sq X 40" Newel Cover, Recessed Panel Four Sides W/9" Wrap & WM164 Base Trim	\$441.61	\$114.31
NRE1240L	12" Sq X 40" Newel Cover, Recessed Panel Two Sides -Line W/9" Wrap & WM164 Base Trim	\$410.31	\$63.46
NRE1240C	12" Sq X 40" Newel Cover, Recessed Panel 2 Sides -Comer W/9" Wrap & WM164 Base Trim	\$401.27	\$63.46
NRE1240E	12" Sq X 40" Newel Cover, Recessed Panel 3 Sides -End W/9" Wrap & WM164 Base Trim	\$435.77	\$88.88
NRE1246	12" Sq X 46" Newel Cover, Recessed Panel Four Sides W/9" Wrap & WM164 Base Trim	\$484.05	\$116.75
NRE1246L	12" Sq X 46" Newel Cover, Recessed Panel Two Sides -Line W/9" Wrap & WM164 Base Trim	\$446.14	\$65.90
NRE1246C	12" Sq X 46" Newel Cover, Recessed Panel 2 Sides -Comer W/9" Wrap & WM164 Base Trim	\$437.10	\$65.90
NRE1246E	12" Sq X 46" Newel Cover, Recessed Panel 3 Sides -End W/9" Wrap & WM164 Base Trim	\$474.91	\$91.32
NRE1250	12" Sq X 50" Newel Cover, Recessed Panel Four Sides W/17" Wrap & WM164 Base Trim	\$533.49	\$118.37
NRE1250L	12" Sq X 50" Newel Cover, Recessed Panel Two Sides -Line W/17" Wrap & WM164 Base Trim	\$491.18	\$67.53
NRE1250C	12" Sq X 50" Newel Cover, Recessed Panel 2 Sides -Comer W/17" Wrap & WM164 Base Trim	\$482.14	\$67.53
NRE1250E	12" Sq X 50" Newel Cover, Recessed Panel 3 Sides -End W/17" Wrap & WM164 Base Trim	\$522.15	\$92.95

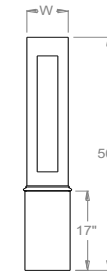
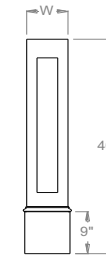
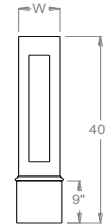

Cellular PVC Newel Covers and Accessories

Item #	Description	List Price	Optional Plant Pricing (If Applicable)	
--------	-------------	------------	--	--

Raised Panel Newels

NRA640	6" Sq X 40" Newel Cover, Raised Panel Four Sides W/9" Wrap & WM164 Base Trim (I.D. is 4-3/4", does not fit a PT6X6)	\$248.15	N/A
NRA640L	6" Sq X 40" Newel Cover, Raised Panel Two Sides -Line W/9" Wrap & WM164 Base Trim (I.D. is 4-3/4", does not fit a PT6X6)	\$242.12	N/A
NRA640C	6" Sq X 40" Newel Cover, Raised Panel Two Sides -Corner W/9" Wrap & WM164 Base Trim (I.D. is 4-3/4", does not fit a PT6X6)	\$236.09	N/A
NRA640E	6" Sq X 40" Newel Cover, Raised Panel Three Sides -End W/9" Wrap & WM164 Base Trim (I.D. is 4-3/4", does not fit a PT6X6)	\$245.13	N/A
NRA646	6" Sq X 46" Newel Cover, Raised Panel Four Sides W/9" Wrap & WM164 Base Trim (I.D. is 4-3/4", does not fit a PT6X6)	\$268.78	N/A
NRA646L	6" Sq X 46" Newel Cover, Raised Panel Two Sides -Line W/9" Wrap & WM164 Base Trim (I.D. is 4-3/4", does not fit a PT6X6)	\$256.73	N/A
NRA646C	6" Sq X 46" Newel Cover, Raised Panel Two Sides -Corner W/9" Wrap & WM164 Base Trim (I.D. is 4-3/4", does not fit a PT6X6)	\$250.70	N/A
NRA646E	6" Sq X 46" Newel Cover, Raised Panel Three Sides -End W/9" Wrap & WM164 Base Trim (I.D. is 4-3/4", does not fit a PT6X6)	\$259.74	N/A
NRA650	6" Sq X 50" Newel Cover, Raised Panel Four Sides W/17" Wrap & WM164 Base Trim (I.D. is 4-3/4", does not fit a PT6X6)	\$295.13	N/A
NRA650L	6" Sq X 50" Newel Cover, Raised Panel Two Sides -Line W/17" Wrap & WM164 Base Trim (I.D. is 4-3/4", does not fit a PT6X6)	\$277.05	N/A
NRA650C	6" Sq X 50" Newel Cover, Raised Panel Two Sides -Corner W/17" Wrap & WM164 Base Trim (I.D. is 4-3/4", does not fit a PT6X6)	\$271.02	N/A
NRA650E	6" Sq X 50" Newel Cover, Raised Panel Three Sides -End W/17" Wrap & WM164 Base Trim (I.D. is 4-3/4", does not fit a PT6X6)	\$280.06	N/A
NRA840	8" Sq X 40" Newel Cover, Raised Panel Four Sides W/9" Wrap & WM164 Base Trim	\$285.71	N/A
NRA840L	8" Sq X 40" Newel Cover, Raised Panel Two Sides -Line W/9" Wrap & WM164 Base Trim	\$279.68	N/A
NRA840C	8" Sq X 40" Newel Cover, Raised Panel Two Sides -Corner W/9" Wrap & WM164 Base Trim	\$273.66	N/A
NRA840E	8" Sq X 40" Newel Cover, Raised Panel Three Sides -End W/9" Wrap & WM164 Base Trim	\$282.70	N/A
NRA846	8" Sq X 46" Newel Cover, Raised Panel Four Sides W/9" Wrap & WM164 Base Trim	\$311.22	N/A
NRA846L	8" Sq X 46" Newel Cover, Raised Panel Two Sides -Line W/9" Wrap & WM164 Base Trim	\$299.16	N/A
NRA846C	8" Sq X 46" Newel Cover, Raised Panel Two Sides -Corner W/9" Wrap & WM164 Base Trim	\$293.14	N/A
NRA846E	8" Sq X 46" Newel Cover, Raised Panel Three Sides -End W/9" Wrap & WM164 Base Trim	\$302.18	N/A
NRA850	8" Sq X 50" Newel Cover, Raised Panel Four Sides W/17" Wrap & WM164 Base Trim	\$344.33	N/A
NRA850L	8" Sq X 50" Newel Cover, Raised Panel Two Sides -Line W/17" Wrap & WM164 Base Trim	\$326.25	N/A
NRA850C	8" Sq X 50" Newel Cover, Raised Panel Two Sides -Corner W/17" Wrap & WM164 Base Trim	\$320.23	N/A
NRA850E	8" Sq X 50" Newel Cover, Raised Panel Three Sides -End W/17" Wrap & WM164 Base Trim	\$329.26	N/A

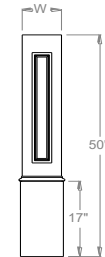
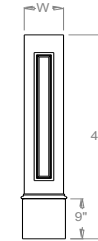
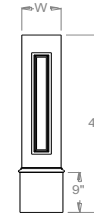

Cellular PVC Newel Covers and Accessories

Item #	Description	List Price	Optional Plant Pricing (If Applicable)	
--------	-------------	------------	--	--

Raised Panel Newels (Continued)

NRA1040	10" Sq X 40" Newel Cover, Raised Panel Four Sides W/9" Wrap & WM164 Base Trim	\$323.27	N/A
NRA1040L	10" Sq X 40" Newel Cover, Raised Panel Two Sides -Line W/9" Wrap & WM164 Base Trim	\$317.25	N/A
NRA1040C	10" Sq X 40" Newel Cover, Raised Panel Two Sides -Comer W/9" Wrap & WM164 Base Trim	\$311.22	N/A
NRA1040E	10" Sq X 40" Newel Cover, Raised Panel Three Sides -End W/9" Wrap & WM164 Base Trim	\$320.26	N/A
NRA1046	10" Sq X 46" Newel Cover, Raised Panel Four Sides W/9" Wrap & WM164 Base Trim	\$353.65	N/A
NRA1046L	10" Sq X 46" Newel Cover, Raised Panel Two Sides -Line W/9" Wrap & WM164 Base Trim	\$341.60	N/A
NRA1046C	10" Sq X 46" Newel Cover, Raised Panel Two Sides -Comer W/9" Wrap & WM164 Base Trim	\$335.57	N/A
NRA1046E	10" Sq X 46" Newel Cover, Raised Panel Three Sides -End W/9" Wrap & WM164 Base Trim	\$344.61	N/A
NRA1050	10" Sq X 50" Newel Cover, Raised Panel Four Sides W/17" Wrap & WM164 Base Trim	\$393.54	N/A
NRA1050L	10" Sq X 50" Newel Cover, Raised Panel Two Sides -Line W/17" Wrap & WM164 Base Trim	\$375.46	N/A
NRA1050C	10" Sq X 50" Newel Cover, Raised Panel Two Sides -Comer W/17" Wrap & WM164 Base Trim	\$369.43	N/A
NRA1050E	10" Sq X 50" Newel Cover, Raised Panel Three Sides -End W/17" Wrap & WM164 Base Trim	\$378.47	N/A
NRA1240	12" Sq X 40" Newel Cover, Raised Panel Four Sides W/9" Wrap & WM164 Base Trim	\$360.84	N/A
NRA1240L	12" Sq X 40" Newel Cover, Raised Panel Two Sides -Line W/9" Wrap & WM164 Base Trim	\$354.81	N/A
NRA1240C	12" Sq X 40" Newel Cover, Raised Panel Two Sides -Comer W/9" Wrap & WM164 Base Trim	\$348.78	N/A
NRA1240E	12" Sq X 40" Newel Cover, Raised Panel Three Sides -End W/9" Wrap & WM164 Base Trim	\$357.82	N/A
NRA1246	12" Sq X 46" Newel Cover, Raised Panel Four Sides W/9" Wrap & WM164 Base Trim	\$396.08	N/A
NRA1246L	12" Sq X 46" Newel Cover, Raised Panel Two Sides -Line W/9" Wrap & WM164 Base Trim	\$384.03	N/A
NRA1246C	12" Sq X 46" Newel Cover, Raised Panel Two Sides -Comer W/9" Wrap & WM164 Base Trim	\$378.00	N/A
NRA1246E	12" Sq X 46" Newel Cover, Raised Panel Three Sides -End W/9" Wrap & WM164 Base Trim	\$387.04	N/A
NRA1250	12" Sq X 50" Newel Cover, Raised Panel Four Sides W/17" Wrap & WM164 Base Trim	\$442.74	N/A
NRA1250L	12" Sq X 50" Newel Cover, Raised Panel Two Sides -Line W/17" Wrap & WM164 Base Trim	\$424.66	N/A
NRA1250C	12" Sq X 50" Newel Cover, Raised Panel Two Sides -Comer W/17" Wrap & WM164 Base Trim	\$418.64	N/A
NRA1250E	12" Sq X 50" Newel Cover, Raised Panel Three Sides -End W/17" Wrap & WM164 Base Trim	\$427.68	N/A

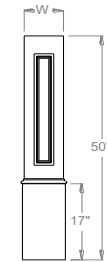
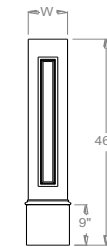
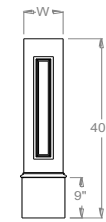

Cellular PVC Newel Covers and Accessories

Item #	Description	List Price	Optional Plant Pricing (If Applicable)	
--------	-------------	------------	--	--

Fluted Panel Newels

NF640	6" Sq X 40" Newel Cover, Fluted Panel Four Sides W/9" Wrap & WM164 Base Trim (I.D. is 4-3/4", does not fit a PT6X6)	\$248.15	N/A
NF640L	6" Sq X 40" Newel Cover, Fluted Panel Two Sides -Line W/9" Wrap & WM164 Base Trim (I.D. is 4-3/4", does not fit a PT6X6)	\$242.12	N/A
NF640C	6" Sq X 40" Newel Cover, Fluted Panel Two Sides -Comer W/9" Wrap & WM164 Base Trim (I.D. is 4-3/4", does not fit a PT6X6)	\$236.09	N/A
NF640E	6" Sq X 40" Newel Cover, Fluted Panel Three Sides -End W/9" Wrap & WM164 Base Trim (I.D. is 4-3/4", does not fit a PT6X6)	\$245.13	N/A
NF646	6" Sq X 46" Newel Cover, Fluted Panel Four Sides W/9" Wrap & WM164 Base Trim (I.D. is 4-3/4", does not fit a PT6X6)	\$268.78	N/A
NF646L	6" Sq X 46" Newel Cover, Fluted Panel Two Sides -Line W/9" Wrap & WM164 Base Trim (I.D. is 4-3/4", does not fit a PT6X6)	\$256.73	N/A
NF646C	6" Sq X 46" Newel Cover, Fluted Panel Two Sides -Comer W/9" Wrap & WM164 Base Trim (I.D. is 4-3/4", does not fit a PT6X6)	\$250.70	N/A
NF646E	6" Sq X 46" Newel Cover, Fluted Panel Three Sides -End W/9" Wrap & WM164 Base Trim (I.D. is 4-3/4", does not fit a PT6X6)	\$259.74	N/A
NF650	6" Sq X 50" Newel Cover, Fluted Panel Four Sides W/17" Wrap & WM164 Base Trim (I.D. is 4-3/4", does not fit a PT6X6)	\$295.13	N/A
NF650L	6" Sq X 50" Newel Cover, Fluted Panel Two Sides -Line W/17" Wrap & WM164 Base Trim (I.D. is 4-3/4", does not fit a PT6X6)	\$277.05	N/A
NF650C	6" Sq X 50" Newel Cover, Fluted Panel Two Sides -Comer W/17" Wrap & WM164 Base Trim (I.D. is 4-3/4", does not fit a PT6X6)	\$271.02	N/A
NF650E	6" Sq X 50" Newel Cover, Fluted Panel Three Sides -End W/17" Wrap & WM164 Base Trim (I.D. is 4-3/4", does not fit a PT6X6)	\$280.06	N/A
NF840	8" Sq X 40" Newel Cover, Fluted Panel Four Sides W/9" Wrap & WM164 Base Trim	\$285.71	N/A
NF840L	8" Sq X 40" Newel Cover, Fluted Panel Two Sides -Line W/9" Wrap & WM164 Base Trim	\$279.68	N/A
NF840C	8" Sq X 40" Newel Cover, Fluted Panel Two Sides -Comer W/9" Wrap & WM164 Base Trim	\$273.66	N/A
NF840E	8" Sq X 40" Newel Cover, Fluted Panel Three Sides -End W/9" Wrap & WM164 Base Trim	\$282.70	N/A
NF846	8" Sq X 46" Newel Cover, Fluted Panel Four Sides W/9" Wrap & WM164 Base Trim	\$311.22	N/A
NF846L	8" Sq X 46" Newel Cover, Fluted Panel Two Sides -Line W/9" Wrap & WM164 Base Trim	\$299.16	N/A
NF846C	8" Sq X 46" Newel Cover, Fluted Panel Two Sides -Comer W/9" Wrap & WM164 Base Trim	\$293.14	N/A
NF846E	8" Sq X 46" Newel Cover, Fluted Panel Three Sides -End W/9" Wrap & WM164 Base Trim	\$302.18	N/A
NF850	8" Sq X 50" Newel Cover, Fluted Panel Four Sides W/17" Wrap & WM164 Base Trim	\$344.33	N/A
NF850L	8" Sq X 50" Newel Cover, Fluted Panel Two Sides -Line W/17" Wrap & WM164 Base Trim	\$326.25	N/A
NF850C	8" Sq X 50" Newel Cover, Fluted Panel Two Sides -Comer W/17" Wrap & WM164 Base Trim	\$320.23	N/A
NF850E	8" Sq X 50" Newel Cover, Fluted Panel Three Sides -End W/17" Wrap & WM164 Base Trim	\$329.26	N/A

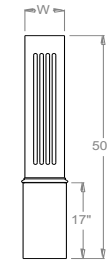
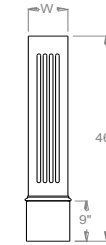
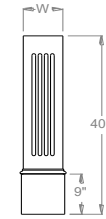

Cellular PVC Newel Covers and Accessories

Item #	Description	List Price	Optional Plant Pricing (If Applicable)	
--------	-------------	------------	--	--

Fluted Panel Newels (Continued)

NF1040	10" Sq X 40" Newel Cover, Fluted Panel Four Sides W/9" Wrap & WM164 Base Trim	\$323.27	N/A
NF1040L	10" Sq X 40" Newel Cover, Fluted Panel Two Sides -Line W/9" Wrap & WM164 Base Trim	\$317.25	N/A
NF1040C	10" Sq X 40" Newel Cover, Fluted Panel Two Sides -Corner W/9" Wrap & WM164 Base Trim	\$311.22	N/A
NF1040E	10" Sq X 40" Newel Cover, Fluted Panel Three Sides -End W/9" Wrap & WM164 Base Trim	\$320.26	N/A
NF1046	10" Sq X 46" Newel Cover, Fluted Panel Four Sides W/9" Wrap & WM164 Base Trim	\$353.65	N/A
NF1046L	10" Sq X 46" Newel Cover, Fluted Panel Two Sides -Line W/9" Wrap & WM164 Base Trim	\$341.60	N/A
NF1046C	10" Sq X 46" Newel Cover, Fluted Panel Two Sides -Corner W/9" Wrap & WM164 Base Trim	\$335.57	N/A
NF1046E	10" Sq X 46" Newel Cover, Fluted Panel Three Sides -End W/9" Wrap & WM164 Base Trim	\$344.61	N/A
NF1050	10" Sq X 50" Newel Cover, Fluted Panel Four Sides W/17" Wrap & WM164 Base Trim	\$393.54	N/A
NF1050L	10" Sq X 50" Newel Cover, Fluted Panel Two Sides -Line W/17" Wrap & WM164 Base Trim	\$375.46	N/A
NF1050C	10" Sq X 50" Newel Cover, Fluted Panel Two Sides -Corner W/17" Wrap & WM164 Base Trim	\$369.43	N/A
NF1050E	10" Sq X 50" Newel Cover, Fluted Panel Three Sides -End W/17" Wrap & WM164 Base Trim	\$378.47	N/A
NF1240	12" Sq X 40" Newel Cover, Fluted Panel Four Sides W/9" Wrap & WM164 Base Trim	\$360.84	N/A
NF1240L	12" Sq X 40" Newel Cover, Fluted Panel Two Sides -Line W/9" Wrap & WM164 Base Trim	\$354.81	N/A
NF1240C	12" Sq X 40" Newel Cover, Fluted Panel Two Sides -Corner W/9" Wrap & WM164 Base Trim	\$348.78	N/A
NF1240E	12" Sq X 40" Newel Cover, Fluted Panel Three Sides -End W/9" Wrap & WM164 Base Trim	\$357.82	N/A
NF1246	12" Sq X 46" Newel Cover, Fluted Panel Four Sides W/9" Wrap & WM164 Base Trim	\$396.08	N/A
NF1246L	12" Sq X 46" Newel Cover, Fluted Panel Two Sides -Line W/9" Wrap & WM164 Base Trim	\$384.03	N/A
NF1246C	12" Sq X 46" Newel Cover, Fluted Panel Two Sides -Corner W/9" Wrap & WM164 Base Trim	\$378.00	N/A
NF1246E	12" Sq X 46" Newel Cover, Fluted Panel Three Sides -End W/9" Wrap & WM164 Base Trim	\$387.04	N/A
NF1250	12" Sq X 50" Newel Cover, Fluted Panel Four Sides W/17" Wrap & WM164 Base Trim	\$442.74	N/A
NF1250L	12" Sq X 50" Newel Cover, Fluted Panel Two Sides -Line W/17" Wrap & WM164 Base Trim	\$424.66	N/A
NF1250C	12" Sq X 50" Newel Cover, Fluted Panel Two Sides -Corner W/17" Wrap & WM164 Base Trim	\$418.64	N/A
NF1250E	12" Sq X 50" Newel Cover, Fluted Panel Three Sides -End W/17" Wrap & WM164 Base Trim	\$427.68	N/A

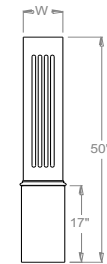
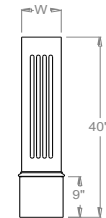

Cellular PVC Newel Covers and Accessories

Item #	Description	List Price	Optional Plant Pricing (If Applicable)	
--------	-------------	------------	--	--

Chamfered Newels

NC640	6" SQ x 40" Newel Cover, Plain Flat Sides, All Four Corners Chamfered, W/9" Base Wrap & WM164 Trim. For Use With Non-Skirted Newel Caps (I.D. is 4-3/4", does not fit a PT6X6)	\$260.75	N/A
NC646	6" SQ x 46" Newel Cover, Plain Flat Sides, All Four Corners Chamfered, W/9" Base Wrap & WM164 Trim. For Use With Non-Skirted Newel Caps (I.D. is 4-3/4", does not fit a PT6X6)	\$277.50	N/A
NC650	6" SQ x 50" Newel Cover, Plain Flat Sides, All Four Corners Chamfered, W/17" Base Wrap & WM164 Trim. For Use With Non-Skirted Newel Caps (I.D. is 4-3/4", does not fit a PT6X6)	\$301.58	N/A
NC840	8" SQ x 40" Newel Cover, Plain Flat Sides, All Four Corners Chamfered, W/9" Base Wrap & WM164 Trim. For Use With Non-Skirted Newel Caps	\$303.47	N/A
NC846	8" SQ x 46" Newel Cover, Plain Flat Sides, All Four Corners Chamfered, W/9" Base Wrap & WM164 Trim. For Use With Non-Skirted Newel Caps	\$325.71	N/A
NC850	8" SQ x 50" Newel Cover, Plain Flat Sides, All Four Corners Chamfered, W/17" Base Wrap & WM164 Trim. For Use With Non-Skirted Newel Caps	\$357.28	N/A
NC1040	10" SQ x 40" Newel Cover, Plain Flat Sides, All Four Corners Chamfered, W/9" Base Wrap & WM164 Trim. For Use With Non-Skirted Newel Caps	\$346.32	N/A
NC1046	10" SQ x 46" Newel Cover, Plain Flat Sides, All Four Corners Chamfered, W/9" Base Wrap & WM164 Trim. For Use With Non-Skirted Newel Caps	\$374.06	N/A
NC1050	10" SQ x 50" Newel Cover, Plain Flat Sides, All Four Corners Chamfered, W/17" Base Wrap & WM164 Trim. For Use With Non-Skirted Newel Caps	\$413.10	N/A
NC1240	12" SQ x 40" Newel Cover, Plain Flat Sides, All Four Corners Chamfered, W/9" Base Wrap & WM164 Trim. For Use With Non-Skirted Newel Caps	\$389.31	N/A
NC1246	12" SQ x 46" Newel Cover, Plain Flat Sides, All Four Corners Chamfered, W/9" Base Wrap & WM164 Trim. For Use With Non-Skirted Newel Caps	\$422.51	N/A
NC1250	12" SQ x 50" Newel Cover, Plain Flat Sides, All Four Corners Chamfered, W/17" Base Wrap & WM164 Trim. For Use With Non-Skirted Newel Caps	\$469.04	N/A
NC640SC	6" Sq X 40" Newel Cover, Plain Flat Sides, All Four Corners Chamfered, W/9" Base Wrap & WM164 Trim. For Use With Skirted Newel Caps (I.D. is 4-3/4", does not fit a PT6X6)	\$260.75	N/A
NC646SC	6" Sq X 46" Newel Cover, Plain Flat Sides, All Four Corners Chamfered, W/9" Base Wrap & WM164 Trim. For Use With Skirted Newel Caps (I.D. is 4-3/4", does not fit a PT6X6)	\$277.50	N/A
NC650SC	6" Sq X 50" Newel Cover, Plain Flat Sides, All Four Corners Chamfered, W/17" Base Wrap & WM164 Trim. For Use With Skirted Newel Caps (I.D. is 4-3/4", does not fit a PT6X6)	\$301.58	N/A
NC840SC	8" Sq X 40" Newel Cover, Plain Flat Sides, All Four Corners Chamfered, W/9" Base Wrap & WM164 Trim. For Use With Skirted Newel Caps	\$303.47	N/A
NC846SC	8" Sq X 46" Newel Cover, Plain Flat Sides, All Four Corners Chamfered, W/9" Base Wrap & WM164 Trim. For Use With Skirted Newel Caps	\$325.71	N/A
NC850SC	8" Sq X 50" Newel Cover, Plain Flat Sides, All Four Corners Chamfered, W/17" Base Wrap & WM164 Trim. For Use With Skirted Newel Caps	\$357.28	N/A
NC1040SC	10" Sq X 40" Newel Cover, Plain Flat Sides, All Four Corners Chamfered, W/9" Base Wrap & WM164 Trim. For Use With Skirted Newel Caps	\$346.32	N/A
NC1046SC	10" Sq X 46" Newel Cover, Plain Flat Sides, All Four Corners Chamfered, W/9" Base Wrap & WM164 Trim. For Use With Skirted Newel Caps	\$374.06	N/A
NC1050SC	10" Sq X 50" Newel Cover, Plain Flat Sides, All Four Corners Chamfered, W/17" Base Wrap & WM164 Trim. For Use With Skirted Newel Caps	\$413.10	N/A
NC1240SC	12" Sq X 40" Newel Cover, Plain Flat Sides, All Four Corners Chamfered, W/9" Base Wrap & WM164 Trim. For Use With Skirted Newel Caps	\$389.31	N/A
NC1246SC	12" Sq X 46" Newel Cover, Plain Flat Sides, All Four Corners Chamfered, W/9" Base Wrap & WM164 Trim. For Use With Skirted Newel Caps	\$422.51	N/A
NC1250SC	12" Sq X 50" Newel Cover, Plain Flat Sides, All Four Corners Chamfered, W/17" Base Wrap & WM164 Trim. For Use With Skirted Newel Caps	\$469.04	N/A

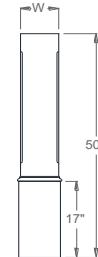

Cellular PVC Newel Covers and Accessories

Item #	Description	List Price	Optional Plant Pricing (If Applicable)
--------	-------------	------------	--

Turned Newels

TDPNC6-40	6-1/4" Diameter X 40" Tall Turned Decorative Porch Newel Cover with Ball Finial	\$1,259.92	N/A
TDPNC6-50	6-1/4" Diameter X 50" Tall Turned Decorative Porch Newel Cover with Ball Finial	\$1,315.99	N/A
TDPNC7-40	7-1/4" Diameter X 40" Tall Turned Decorative Porch Newel Cover with Ball Finial	\$1,346.91	N/A
TDPNC7-50	7-1/4" Diameter X 50" Tall Turned Decorative Porch Newel Cover with Ball Finial	\$1,419.96	N/A
TDPNC9-40	9-5/8" Diameter X 40" Tall Turned Decorative Porch Newel Cover with Ball Finial	\$1,615.40	N/A
TDPNC9-50	9-5/8" Diameter X 50" Tall Turned Decorative Porch Newel Cover with Ball Finial	\$1,743.38	N/A

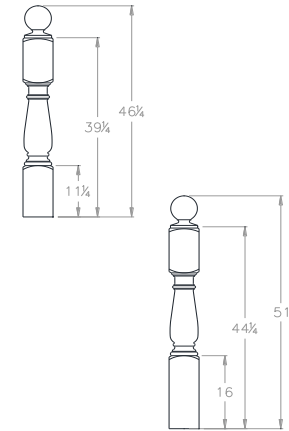

Newel Mounting Accessories

NEWELPOST36/42	Intex HD Newel Post Mount W/Poly Guides and Shims, For 36" or 42" Rail Height.	\$126.06
NEWELMOUNT-C	Intex Post Mount System, Mounting Hardware for Concrete/Masonry Application	\$29.35
NEWELMOUNT-W	Intex Post Mount System, Mounting Hardware for Wood/Composite Application	\$40.19
NEWELPOSTBLOCK	Intex Poly Spacer Guide Block for Newel Post Mount. 3-1/2" Square x 6-3/4" (Extra Block for 3-line Rail)	\$14.82

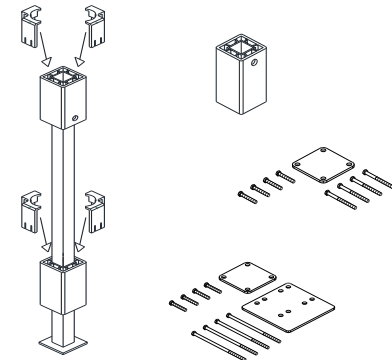

Cellular PVC Newel Covers and Accessories

Item #	Description	List Price	Optional Plant Pricing (If Applicable)	
--------	-------------	------------	--	--

Flat 2-Tier Newel Cap

			W
NTC5	Flat 2-Tier Newel Cap For 5" Newel Cover		
NTC6	Flat 2-Tier Newel Cap For 6" Newel Cover	\$54.18	8 1/4
NTC8	Flat 2-Tier Newel Cap For 8" Newel Cover	\$65.32	10 1/4
NTC10	Flat 2-Tier Newel Cap For 10" Newel Cover	\$79.41	12 1/4
NTC12	Flat 2-Tier Newel Cap For 12" Newel Cover	\$96.42	14 1/4

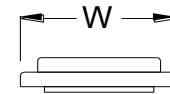

Flat 2-Tier Newel Cap w/ WM75 Trim

			W
NTC5	Flat 2-Tier Newel Cap with WM75 Trim For 5" Newel Cover		
NTC6	Flat 2-Tier Newel Cap with WM75 Trim For 6" Newel Cover	\$69.24	
NTC8	Flat 2-Tier Newel Cap with WM75 Trim For 8" Newel Cover	\$77.30	
NTC10	Flat 2-Tier Newel Cap with WM75 Trim For 10" Newel Cover	\$95.63	
NTC12	Flat 2-Tier Newel Cap with WM75 Trim For 12" Newel Cover	\$105.57	



Flat 2-Tier Newel Cap w/Ball Finial

			W
NTC5B	Flat 2-Tier Newel Cap For 5" Newel Cover & 3-1/2" Ball Finial	\$127.41	7 1/4
NTC6B	Flat 2-Tier Newel Cap For 6" Newel Cover & 3-1/2" Ball Finial	\$141.35	8 1/4
NTC8B	Flat 2-Tier Newel Cap For 8" Newel Cover & 4" Ball Finial	\$168.04	10 1/4
NTC10B	Flat 2-Tier Newel Cap For 10" Newel Cover & 5" Ball Finial	\$197.67	12 1/4
NTC12B	Flat 2-Tier Newel Cap For 12" Newel Cover & 5" Ball Finial	\$214.68	14 1/4

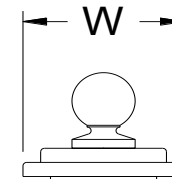

Flat 2-Tier Newel Cap w/WM287 Rake Skirt

			W
NTCR6	Flat 2-Tier Newel Cap W/WM287 Rake Trim For 6" Newel Cover	\$74.30	8 1/4
NTCR8	Flat 2-Tier Newel Cap W/WM287 Rake Trim For 8" Newel Cover	\$87.07	10 1/4
NTCR10	Flat 2-Tier Newel Cap W/WM287 Rake Trim For 10" Newel Cover	\$102.11	12 1/4
NTCR12	Flat 2-Tier Newel Cap W/WM287 Rake Trim For 12" Newel Cover	\$119.43	14 1/4

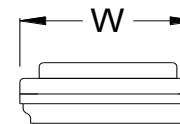

Cellular PVC Newel Covers and Accessories

Item #	Description	List Price	Optional Plant Pricing (If Applicable)	
--------	-------------	------------	--	--

Pyramidal Newel Cap w/WM75 Bed trim

			W	
NPTC6	Pyramidal Newel Cap W/WM75 Bed Trim For 6" Newel Cover	\$116.76	8 3/4	
NPTC8	Pyramidal Newel Cap W/WM75 Bed Trim For 8" Newel Cover	\$129.16	10 3/4	
NPTC10	Pyramidal Newel Cap W/WM75 Bed Trim For 10" Newel Cover	\$141.56	12 3/4	
NPTC12	Pyramidal Newel Cap W/WM75 Bed Trim For 12" Newel Cover	\$176.06	14 3/4	

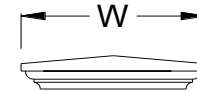

Pyramidal Newel Cap w/Skirt, WM164 & WM75 Trim for 40" & 46" Newel

NPTC6-S40	Pyramidal Newel Cap W/Skirt, WM75 & WM164 Trim, For 6" X 40/46" Newel	\$149.26	9 1/2	
NPTC8-S40	Pyramidal Newel Cap W/Skirt, WM75 & WM164 Trim, For 8" X 40/46" Newel	\$157.79	11 1/2	
NPTC10-S40	Pyramidal Newel Cap W/Skirt, WM75 & WM164 Trim, For 10" X 40/46" Newel	\$165.73	13 1/2	
NPTC12-S40	Pyramidal Newel Cap W/Skirt, WM75 & WM164 Trim, For 12" X 40/46" Newel	\$204.30	15 1/2	

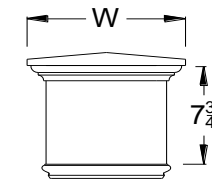

Pyramidal Newel Cap w/Skirt, WM164 & WM75 Trim for 50" Newel

NPTC6-S50	Pyramidal Newel Cap W/Skirt, WM75 & WM164 Trim, For 6" X 50" Newel	\$161.36	9 1/2	
NPTC8-S50	Pyramidal Newel Cap W/Skirt, WM75 & WM164 Trim, For 8" X 50" Newel	\$170.10	11 1/2	
NPTC10-S50	Pyramidal Newel Cap W/Skirt, WM75 & WM164 Trim, For 10" X 50" Newel	\$178.66	13 1/2	
NPTC12-S50	Pyramidal Newel Cap W/Skirt, WM75 & WM164 Trim, For 12" X 50" Newel	\$219.94	15 1/2	

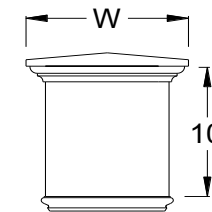

3-Tier Newel cap w/WM75 Bed Trim

			W	
NTTC6-75B	Three-Tier Newel Cap W/WM75 Bed Trim For 6" Newel Cover	\$75.55	8 3/4	
NTTC8-75B	Three-Tier Newel Cap W/WM75 Bed Trim For 8" Newel Cover	\$114.16	10 3/4	
NTTC10-75B	Three-Tier Newel Cap W/WM75 Bed Trim For 10" Newel Cover	\$130.73	12 3/4	
NTTC12-75B	Three-Tier Newel Cap W/WM75 Bed Trim For 12" Newel Cover	\$150.26	14 3/4	

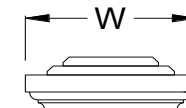

Cellular PVC Newel Covers and Accessories

Item #	Description	List Price	Optional Plant Pricing (If Applicable)	
--------	-------------	------------	--	--

3-Tier Newel cap w/WM75 Bed Trim & Ball Finial

			W	
NTTC5-75BB	Three-Tier Newel Cap W/WM75 Bed Trim & 3-1/2" Ball Finial For 5" Newel Cover	\$153.03	7 3/4	
NTTC6-75BB	Three-Tier Newel Cap W/WM75 Bed Trim & 3-1/2" Ball Finial For 6" Newel Cover	\$162.72	8 3/4	
NTTC8-75BB	Three-Tier Newel Cap W/WM75 Bed Trim & 4" Ball Finial For 8" Newel Cover	\$216.88	10 3/4	
NTTC10-75BB	Three-Tier Newel Cap W/WM75 Bed Trim & 5" Ball Finial For 10" Newel Cover	\$248.99	12 3/4	
NTTC12-75BB	Three-Tier Newel Cap W/WM75 Bed Trim & 5" Ball Finial For 12" Newel Cover	\$268.52	14 3/4	

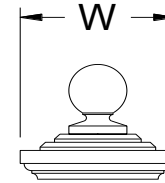

3-Tier Newel Cap w/Skirt and WM164 Trim for 40" & 46" Newel

NTTC640	Three-Tier Newel Cap W/Skirt & WM164 Trim, For 6" X 40/46" Newel	\$116.58	8 3/4	
NTTC840	Three-Tier Newel Cap W/Skirt & WM164 Trim, For 8" X 40/46" Newel	\$134.26	10 3/4	
NTTC1040	Three-Tier Newel Cap W/Skirt & WM164 Trim, For 10" X 40/46" Newel	\$154.90	12 3/4	
NTTC1240	Three-Tier Newel Cap W/Skirt & WM164 Trim, For 12" X 40/46" Newel	\$178.50	14 3/4	

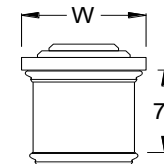

3-Tier Newel Cap w/Skirt, WM164 Trim and Ball Finial for 40" & 46" Newel

NTTC640B	Three-Tier Newel Cap W/Skirt & WM164 Trim & 3-1/2" Ball Finial, For 6" X 40/46" Newel	\$203.75	8 3/4	
NTTC840B	Three-Tier Newel Cap W/Skirt & WM164 Trim & 4" Ball Finial, For 8" X 40/46" Newel	\$236.98	10 3/4	
NTTC1040B	Three-Tier Newel Cap W/Skirt & WM164 Trim & 5" Ball Finial, For 10" X 40/46" Newel	\$273.16	12 3/4	
NTTC1240B	Three-Tier Newel Cap W/Skirt & WM164 Trim & 5" Ball Finial, For 12" X 40/46" Newel	\$296.76	14 3/4	

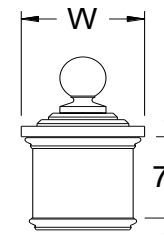

3-Tier Newel cap w/Skirt and WM164 Trim for 50" Newel

			W	
NTTC650	Three-Tier Newel Cap W/Skirt & WM164 Trim, For 6" X 50" Newel	\$120.15	8 3/4	
NTTC850	Three-Tier Newel Cap W/Skirt & WM164 Trim, For 8" X 50" Newel	\$138.88	10 3/4	
NTTC1050	Three-Tier Newel Cap W/Skirt & WM164 Trim, For 10" X 50" Newel	\$160.57	12 3/4	
NTTC1250	Three-Tier Newel Cap W/Skirt & WM164 Trim, For 12" X 50" Newel	\$185.23	14 3/4	

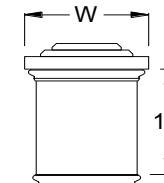

3-Tier Newel Cap w/Skirt, WM164 Trim and Ball Finial for 50" Newel

			W	
NTTC650B	Three-Tier Newel Cap W/Skirt & WM164 Trim & 3-1/2" Ball Finial, For 6" X 50" Newel	\$207.32	8 3/4	
NTTC850B	Three-Tier Newel Cap W/Skirt & WM164 Trim & 4" Ball Finial, For 8" X 50" Newel	\$241.60	10 3/4	
NTTC1050B	Three-Tier Newel Cap W/Skirt & WM164 Trim & 5" Ball Finial, For 10" X 50" Newel	\$278.83	12 3/4	
NTTC1250B	Three-Tier Newel Cap W/Skirt & WM164 Trim & 5" Ball Finial, For 12" X 50" Newel	\$303.49	14 3/4	

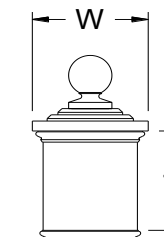

Cellular PVC Newel Covers and Accessories

Item #	Description	List Price	Optional Plant Pricing (If Applicable)	
--------	-------------	------------	--	--

Harbor Style Newel Caps

			W	
NHC5	Harbor Style Newel Cap w/Pyramid Top, for 5" Square Newel. Prime Coat Applied	\$107.75	6 1/2	
NHC6	Harbor Style Newel Cap w/Pyramid Top, for 6" Square Newel. Prime Coat Applied	\$112.52	7 1/2	
NHC8	Harbor Style Newel Cap w/Pyramid Top, for 8" Square Newel. Prime Coat Applied	\$122.02	9 1/2	
NHC10	Harbor Style Newel Cap w/Pyramid Top, for 10" Square Newel. Prime Coat Applied	\$139.26	11 1/2	
NHC12	Harbor Style Newel Cap w/Pyramid Top, for 12" Square Newel. Prime Coat Applied	\$157.09	13 1/2	

NHCF5	Harbor Style Newel Cap w/Flat Top, for 5" Square Newel. Prime Coat Applied	\$102.72	6 1/2	
NHCF6	Harbor Style Newel Cap w/Flat Top, for 6" Square Newel. Prime Coat Applied	\$107.21	7 1/2	
NHCF8	Harbor Style Newel Cap w/Flat Top, for 8" Square Newel. Prime Coat Applied	\$111.31	9 1/2	
NHCF10	Harbor Style Newel Cap w/Flat Top, for 10" Square Newel. Prime Coat Applied	\$117.19	11 1/2	
NHCF12	Harbor Style Newel Cap w/Flat Top, for 12" Square Newel. Prime Coat Applied	\$126.37	13 1/2	

NHCFC5	Harbor Style Newel Cap w/Flat-Chamfered Top, for 5" Square Newel. Prime Coat Applied	\$105.88	6 1/2	
NHCFC6	Harbor Style Newel Cap w/Flat-Chamfered Top, for 6" Square Newel. Prime Coat Applied	\$108.49	7 1/2	
NHCFC8	Harbor Style Newel Cap w/Flat-Chamfered Top, for 8" Square Newel. Prime Coat Applied	\$114.42	9 1/2	
NHCFC10	Harbor Style Newel Cap w/Flat-Chamfered Top, for 10" Square Newel. Prime Coat Applied	\$120.99	11 1/2	
NHCFC12	Harbor Style Newel Cap w/Flat-Chamfered Top, for 12" Square Newel. Prime Coat Applied	\$129.53	13 1/2	

Island Style Newel Caps

			W	
NICP5	Island Style Newel Cap w/Pyramid Top, for 5" Square Newel. Prime Coat Applied	\$107.75	6 3/4	
NICP6	Island Style Newel Cap w/Pyramid Top, for 6" Square Newel. Prime Coat Applied	\$112.52	7 3/4	
NICP8	Island Style Newel Cap w/Pyramid Top, for 8" Square Newel. Prime Coat Applied	\$122.02	9 3/4	
NICP10	Island Style Newel Cap w/Pyramid Top, for 10" Square Newel. Prime Coat Applied	\$139.26	11 3/4	
NICP12	Island Style Newel Cap w/Pyramid Top, for 12" Square Newel. Prime Coat Applied	\$157.09	13 3/4	

Cellular PVC Newel Covers and Accessories

Item #	Description	List Price	Optional Plant Pricing (If Applicable)	
--------	-------------	------------	--	--

Island Style Newel Caps (Continued)

			W	
NICF5	Island Style Newel Cap w/Flat Top, for 5" Square Newel. Prime Coat Applied	\$102.72	6 3/4	
NICF6	Island Style Newel Cap w/Flat Top, for 6" Square Newel. Prime Coat Applied	\$107.21	7 3/4	
NICF8	Island Style Newel Cap w/Flat Top, for 8" Square Newel. Prime Coat Applied	\$111.31	9 3/4	
NICF10	Island Style Newel Cap w/Flat Top, for 10" Square Newel. Prime Coat Applied	\$117.19	11 3/4	
NICF12	Island Style Newel Cap w/Flat Top, for 12" Square Newel. Prime Coat Applied	\$126.37	13 3/4	
.....				
NICFC5	Island Style Newel Cap w/Flat-Chamfered Top, for 5" Square Newel. Prime Coat Applied	\$105.88	6 3/4	
NICFC6	Island Style Newel Cap w/Flat-Chamfered Top, for 6" Square Newel. Prime Coat Applied	\$108.49	7 3/4	
NICFC8	Island Style Newel Cap w/Flat-Chamfered Top, for 8" Square Newel. Prime Coat Applied	\$114.42	9 3/4	
NICFC10	Island Style Newel Cap w/Flat-Chamfered Top, for 10" Square Newel. Prime Coat Applied	\$120.99	11 3/4	
NICFC12	Island Style Newel Cap w/Flat-Chamfered Top, for 12" Square Newel. Prime Coat Applied	\$129.53	13 3/4	

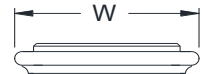

Triton Style Newel Caps

			W	
NTCT5	Triton Style Newel Cap for 5" Square Newel, Three Tier with WM52 Skirt. Prime Coat Applied.	\$148.74	9 1/4	
NTCT6	Triton Style Newel Cap for 6" Square Newel, Three Tier with WM52 Skirt. Prime Coat Applied.	\$155.16	10 1/4	
NTCT8	Triton Style Newel Cap for 8" Square Newel, Three Tier with WM52 Skirt. Prime Coat Applied.	\$169.83	12 1/4	
NTCT10	Triton Style Newel Cap for 10" Square Newel, Three Tier with WM52 Skirt. Prime Coat Applied.	\$182.17	14 1/4	
NTCT12	Triton Style Newel Cap for 12" Square Newel, Three Tier with WM52 Skirt. Prime Coat Applied.	\$207.56	16 1/4	

