

# Nautilus RS10-375 Top Rail

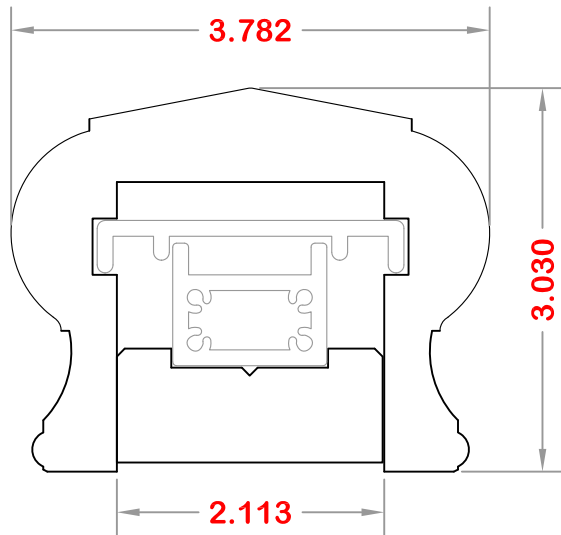

# Nautilus RS10-375 Bottom Rail

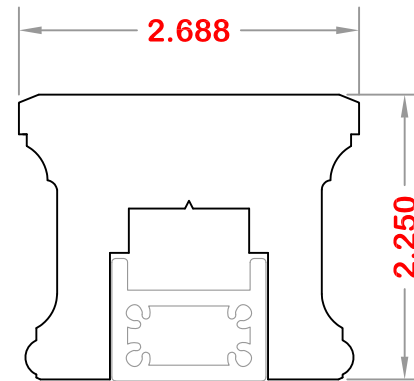

**INTEX**  
MILLWORK SOLUTIONS

Drawing Date:  
06/11/2011

Quote Number:  
JU

Product Description:  
Nautilus RS10-375  
Rail System

Drawing #:

Drawn By:  
J.Umosella

Scale:  
XX

No:	Date:	Revision:
1	XX-XX-XX	XX
2	XX-XX-XX	XX

DWG#

# Nautilus RS10-375 Rail System

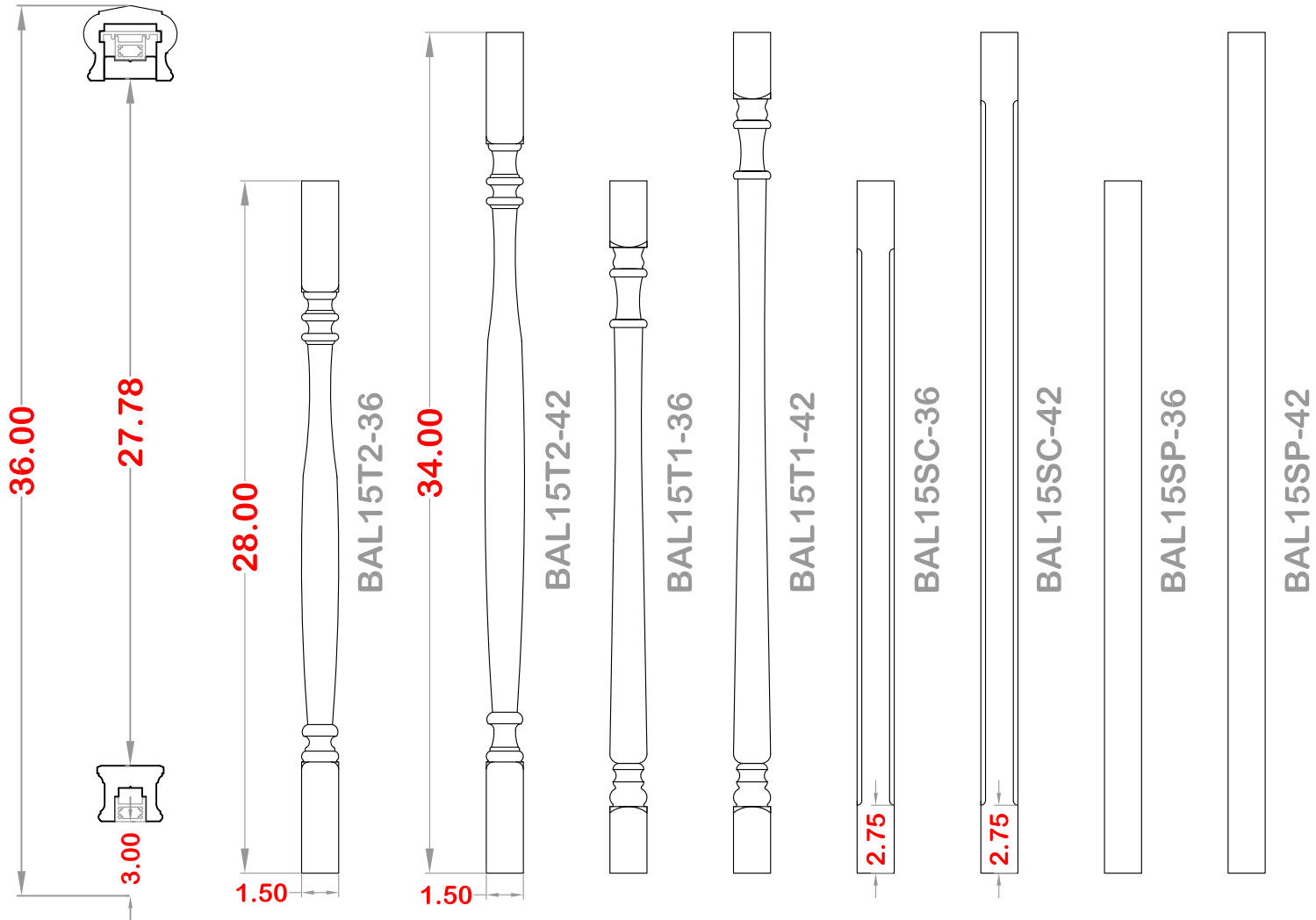

**INTEX**  
MILLWORK SOLUTIONS

Drawing Date:  
06/11/2011

Quote Number:  
JU

Product Description:  
Nautilus RS10-375  
Rail System

Drawing #:

Drawn By:  
J.Umosella

Scale:  
XX

No:	Date:	Revision:
1	XX-XX-XX	XX
2	XX-XX-XX	XX

DWG#

# Nautilus RS20-500 Top Rail

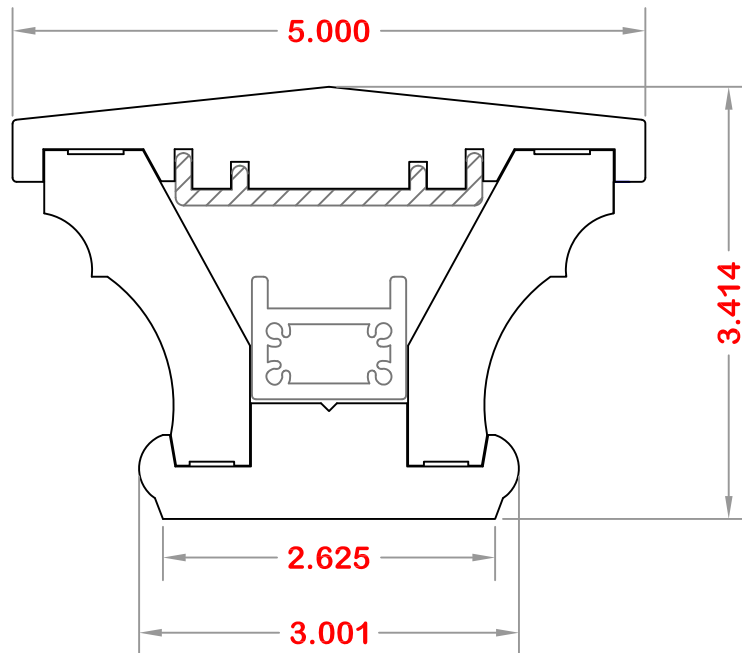

# Nautilus RS20-500 Bottom Rail

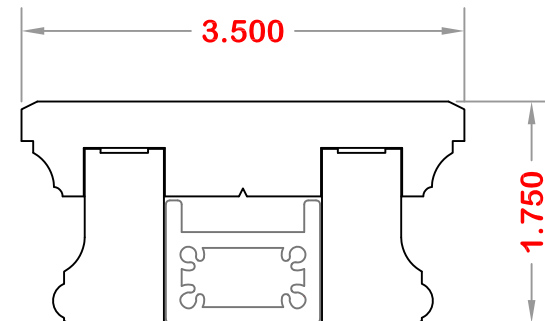

**INTEX**  
MILLWORK SOLUTIONS

Drawing Date:

06/11/2011

Quote Number:

JU

Product Description:

Nautilus RS20-500  
Rail System

No:	Date:	Revision:
1	XX-XX-XX	XX
2	XX-XX-XX	XX

Drawn By:  
J.Umosella

Scale:  
XX

Drawing #:

DWG#

PATH

# Nautilus RS20-500 Rail System

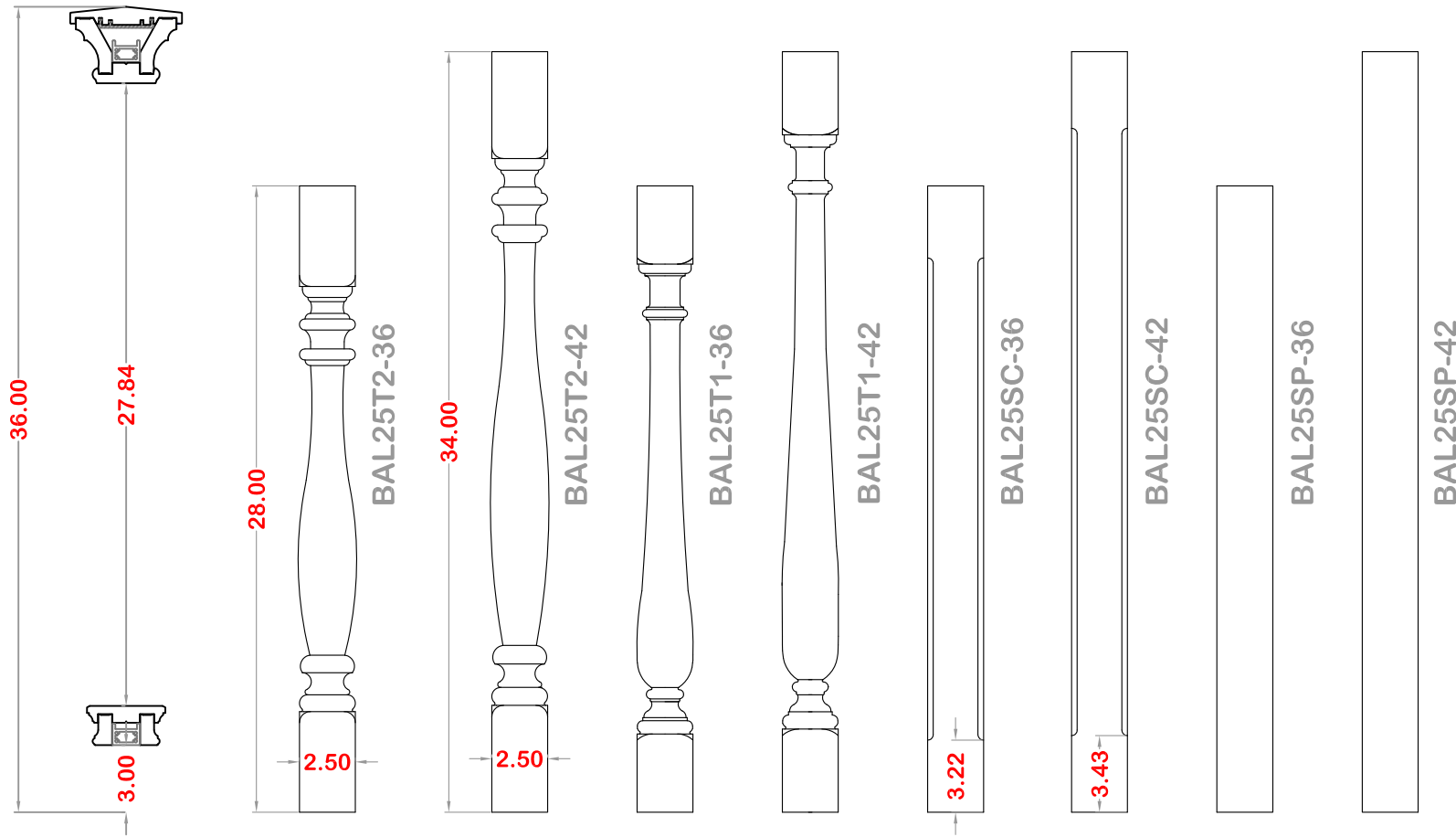

**INTEX**  
MILLWORK SOLUTIONS

Drawing Date:  
06/11/2011

Quote Number:  
JU

Product Description:  
Nautilus RS20-500  
Rail System

Drawing #:

Drawn By:  
J.Umosella

Scale:  
XX

No:	Date:	Revision:
1	XX-XX-XX	XX
2	XX-XX-XX	XX

DWG#

# Nautilus RS10-600 Top Rail

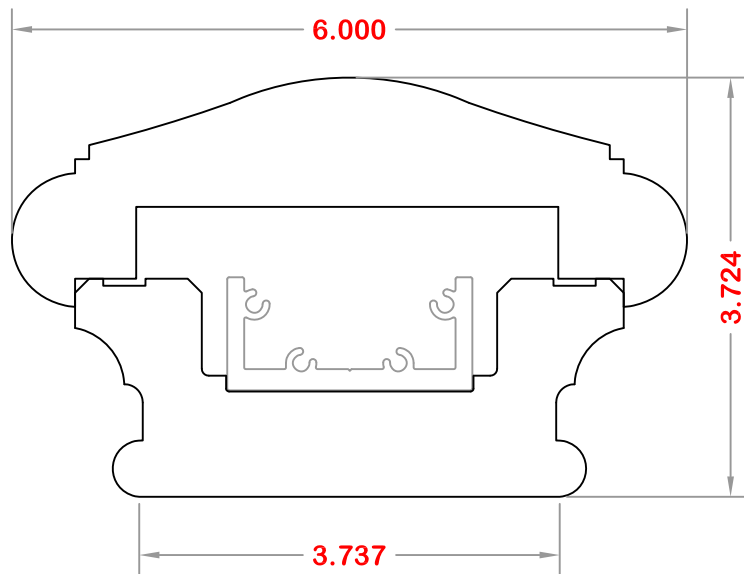

# Nautilus RS10-600 Bottom Rail

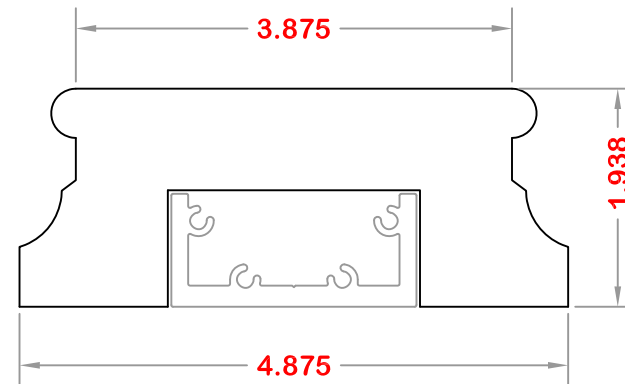

**INTEX**  
MILLWORK SOLUTIONS

Drawing Date:  
06/11/2011

Quote Number:  
JU

Product Description:  
Nautilus RS10-600  
Rail System

Drawing #:

Drawn By:  
J.Umosella

Scale:  
XX

No:	Date:	Revision:
1	XX-XX-XX	XX
2	XX-XX-XX	XX

DWG#

# Nautilus RS10-600 Rail System

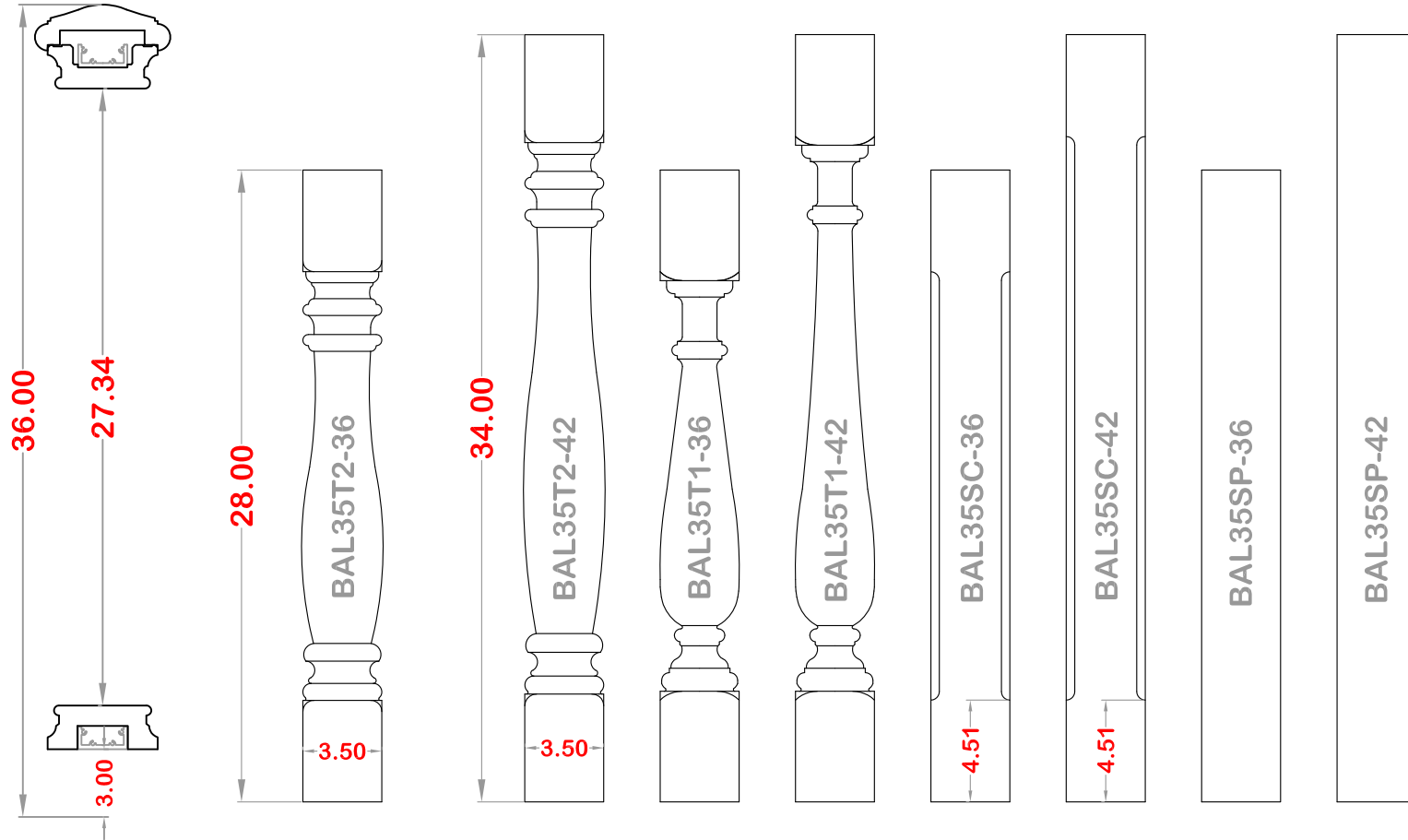

**INTEX**  
MILLWORK SOLUTIONS

Drawing Date:  
06/11/2011

Quote Number:  
JU

Product Description:  
Nautilus RS10-600  
Rail System

Drawing #:

Drawn By:  
J.Umosella

Scale:  
XX

No:	Date:	Revision:
1	XX-XX-XX	XX
2	XX-XX-XX	XX

DWG#

# Nautilus RS20-700 Top Rail

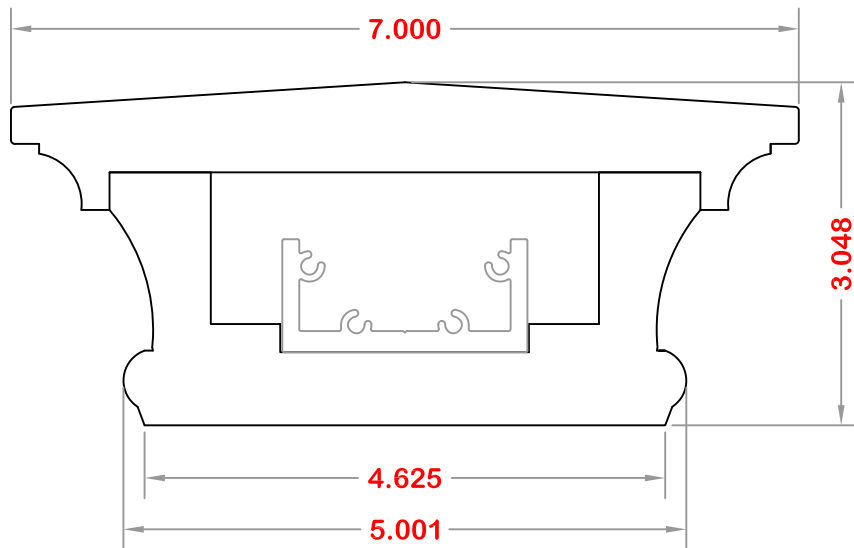

# Nautilus RS20-700 Bottom Rail

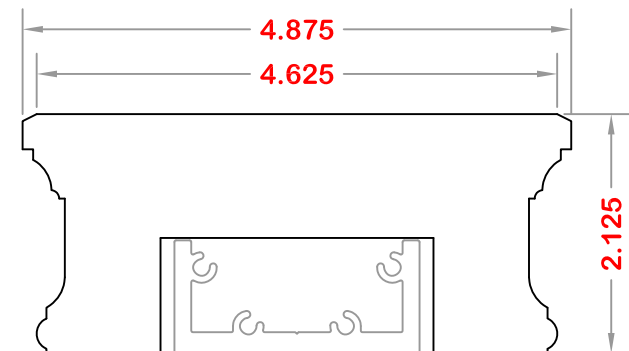

**INTEX**  
MILLWORK SOLUTIONS

Drawing Date:

06/11/2011

Quote Number:

JU

Product Description:

Nautilus RS20-700  
Rail System

No:	Date:	Revision:
1	XX-XX-XX	XX
2	XX-XX-XX	XX

Drawn By:  
J.Umosella

Scale:  
XX

Drawing #:

DWG#

# Nautilus RS20-700 Rail System

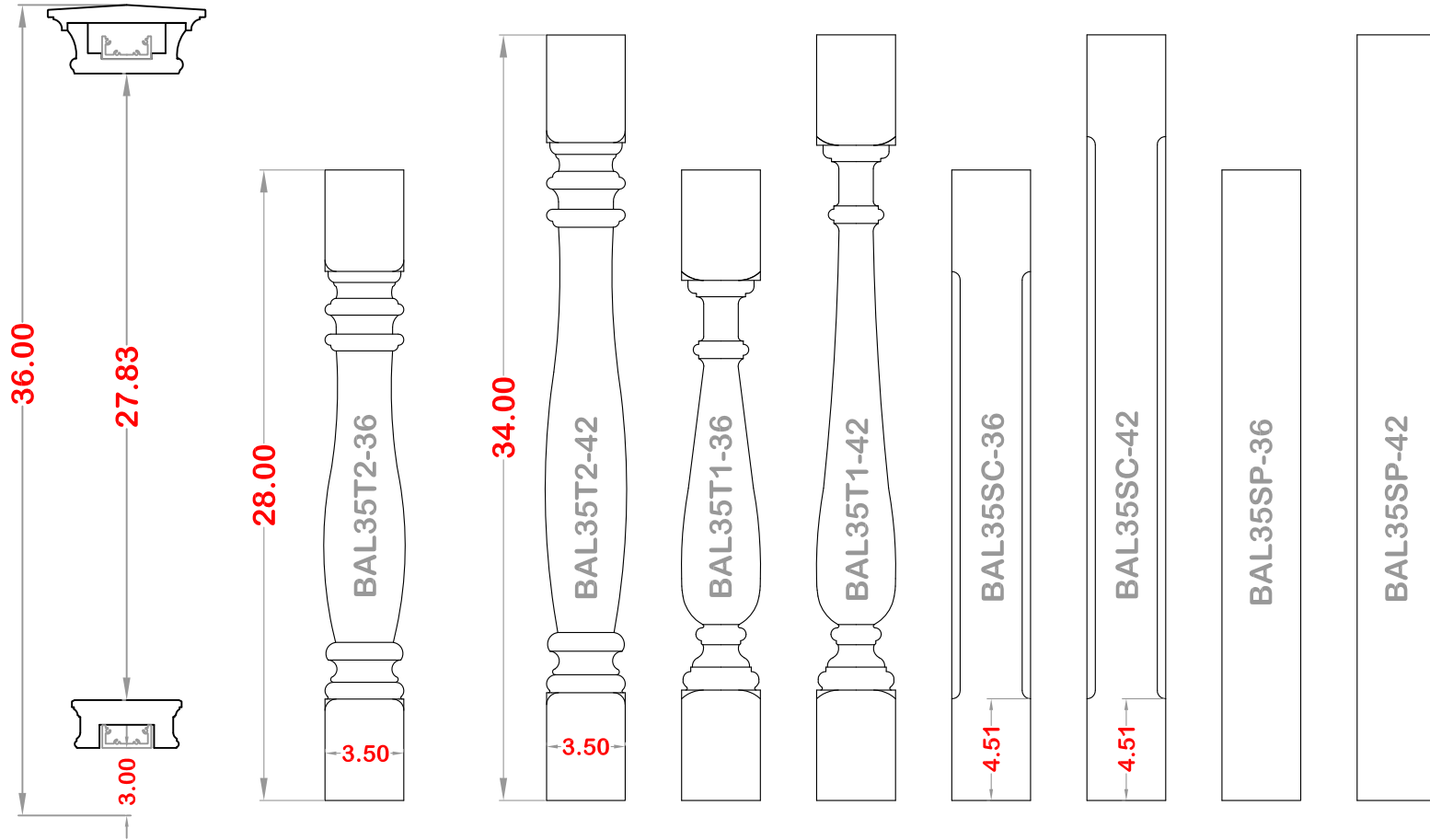

**INTEX**  
MILLWORK SOLUTIONS

Drawing Date:

06/11/2011

Quote Number:

JU

Product Description:

Nautilus RS20-700  
Rail System

No:	Date:	Revision:
1	XX-XX-XX	XX
2	XX-XX-XX	XX

Drawn By:  
J.Umosella

Scale:  
XX

Drawing #:

DWG#

PATH



# Nautilus RS20-800 Top Rail

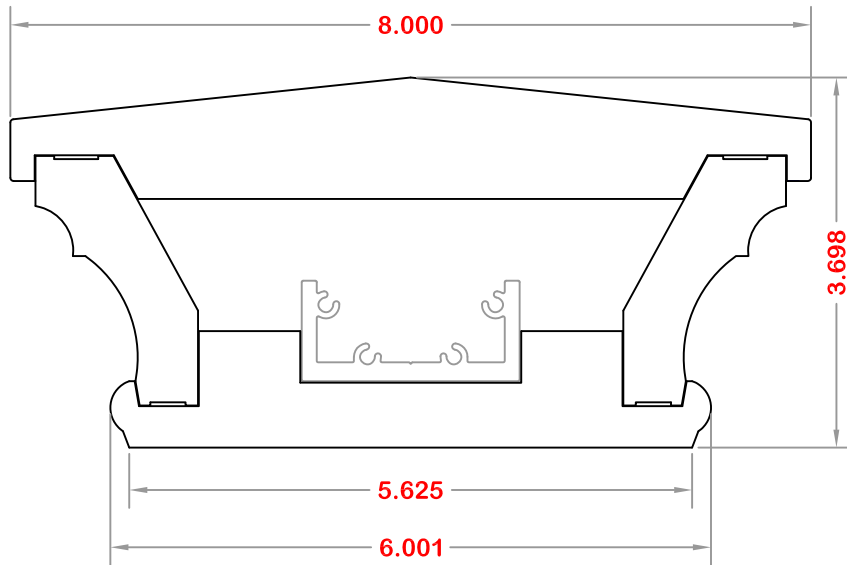

# Nautilus RS20-800 Bottom Rail

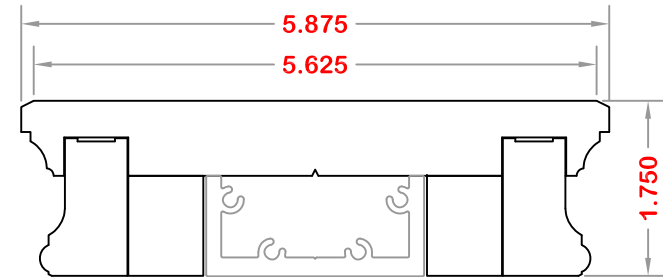

**INTEX**  
MILLWORK SOLUTIONS

Drawing Date:  
06/11/2011

Quote Number:  
JU

Product Description:  
Nautilus RS20-800  
Rail System

Drawing #:

DWG#

Drawn By:  
J.Umosella

Scale:  
XX

No:	Date:	Revision:
1	XX-XX-XX	XX
2	XX-XX-XX	XX

# Nautilus RS20-800 Rail System

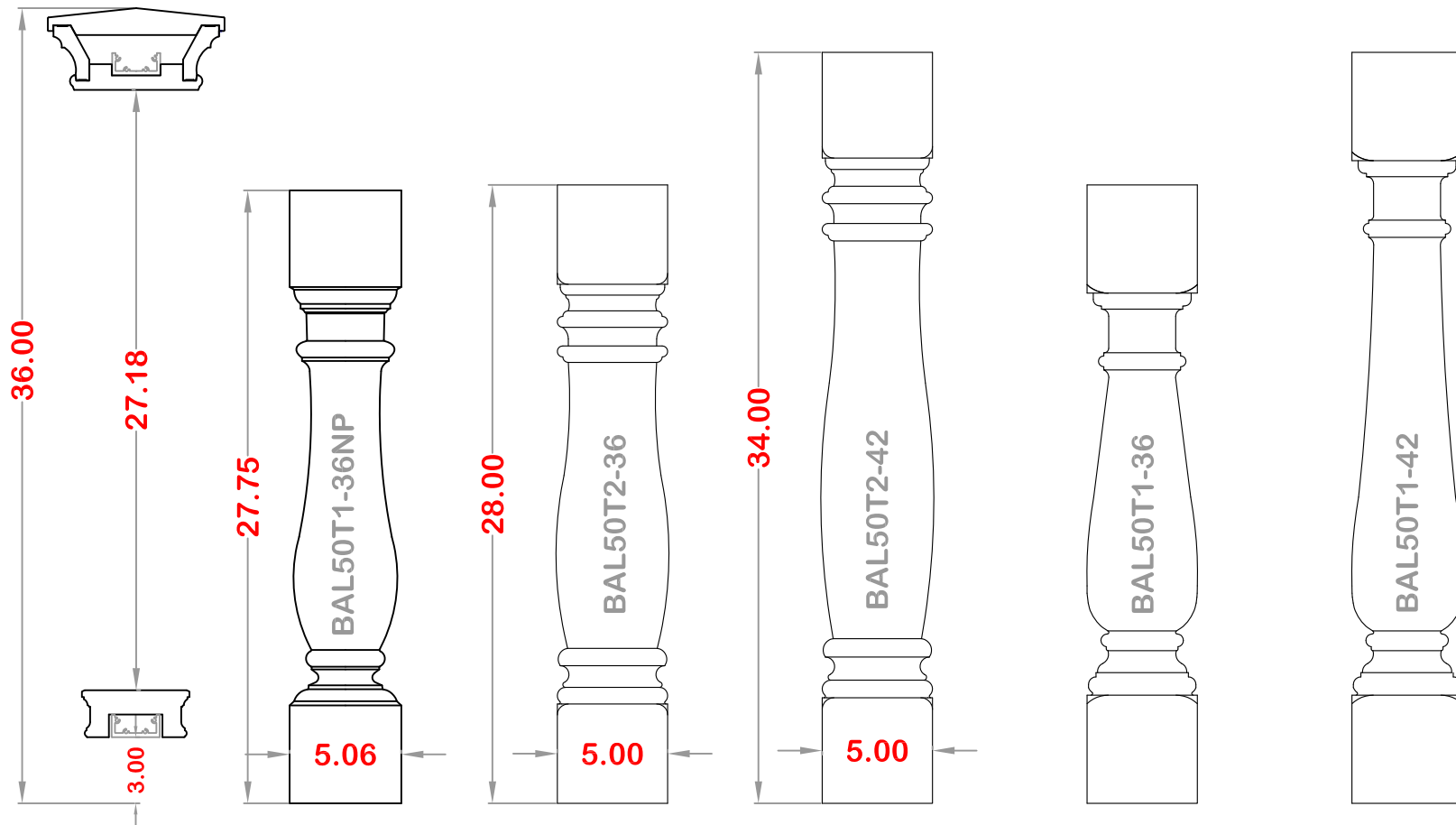

**INTEX**  
MILLWORK SOLUTIONS

Drawing Date:  
06/11/2011

Quote Number:  
JU

Product Description:  
Nautilus RS20-800  
Rail System

Drawing #:

Drawn By:  
J.Umosella

Scale:  
XX

No:	Date:	Revision:
1	XX-XX-XX	XX
2	XX-XX-XX	XX

DWG#

PATH