



# Marketing Materials Order Form

Ship To:	Request Date
.....	.....
Attn:	Date Needed:
.....	.....
Address:	Distributor Order #
.....	.....
City/State/Zip:	Phone#
.....	.....
Distributor Acct:	.....

Part #	LITERATURE	Min Order	Qty Requested	Value	Marketing Support Charged
INTEXBR76P	INTEX Catalog/Brochure, 76 Page, All Products	Each	.....	\$1.99	.....
INTEXRS40DT	INTEX Hampton RS40 Tri-Fold Pocket Literature, 4" x 9" Pack size 50 each.	Each	.....	\$0.13	.....
INTEXRS60DT	INTEX Liberty RS60 Tri-Fold Pocket Literature, 4" x 9" Pack size 50 each.	Each	.....	\$0.13	.....
INTEXRS35DT	INTEX Dartmouth RS30 Tri-Fold Pocket Literature, 4" x 9" Pack size 50 each.	Each	.....	\$0.13	.....

### SLEEVE SAMPLES

EASYSAMP	Easy-Wrap Column Sample w/Graphic, 4-1/2" Sq x 6-1/2".	Each	.....	\$10.34	.....
EASYWRAPDISP	Easy-Wrap Counter Display, 4-1/2" SQ & 6-1/2" SQ, Graphics, 75 Bed Trim, Brown Painted Base	Each	.....	\$102.99	.....
NRE-NRASAMP	INTEX Newel Sample 8" x 24" with Recessed & Raised Panels, Flat, with Base Wrap & WM164 Trim	Each	.....	\$49.25	.....
SQCOLSAMP	6" SQ x 18" Column Wrap Sample- Multi Faced, with 2" Cap and 6" Base Wrap & 164BC Trim	Each	.....	\$68.26	.....
TCOLSAMP	Square Tapered Column Sample Multi faced, 5/8" Wall, 8" to 6" Taper, 18" Tall, with WM75 Cap and Base Trim, 5/8" Thick Cap and Base Plates	Each	.....	\$73.04	.....
COLUMNDISP	Column wrap counter display, Multi design faces. Tapered and Square, with lit holder and flyers	Each	.....	\$190.42	.....

### PERGOLA SAMPLES/DISPLAYS

EPR7SAMPLE	Engineered Pergola 7" Rafter Sample, w/PT1 Tail and Aluminum Reinforcement	Each	.....	\$52.49	.....
EPR9SAMPLE	Engineered Pergola 9" Rafter Sample, w/PT1 Tail and Aluminum Reinforcement	Each	.....	\$56.96	.....
PKR5SAMPLE	Classic Kit Pergola 5" Rafter Sample, with PT1 Tail and Aluminum Reinforcement	Each	.....	\$34.21	.....
PERGDISP	INTEX Pergola Rafter Display, Rafter Variations with PT1 Tails on 8" Recessed Column with INC004 Inlays	Each	.....	\$412.25	.....

**GUTTER SAMPLES/DISPLAYS**

GUTTERCARRY	Display, Salesman for Gutter, Include Gutter, Hardware, Outlet, Carry-With, No Stand	Each	\$202.57
GUTTERDISP	Display, INTEX Gutter System, Gutter, Hardware, Outlet, with Graphics, for Counter-Top	Each	\$253.93
GUTTERSAMP	Boston PVC Gutter Sample, 4" Length, with Label, Includes Bracket Mounting Components	Each	\$9.26

**RAILING MINI SAMPLES**

RS10375SAMP	Sample RS10375 Rail Cut 6" Top and Bottom Sections with Reinforcement	Each	\$17.40
RS10600SAMP	Sample RS10600 Rail Cut 6", Top and Bottom Section and Reinforcement	Each	\$18.95
RS20500SAMP	Sample RS20500 Rail Cut 6", Top and Bottom Section and Reinforcement Plus Optional Wood cap	Each	\$30.10
RS20700SAMP	Sample RS20700 Rail Cut 6" Top and Bottom Sections with Reinforcement	Each	\$28.26
RS20800SAMP	Sample RS20800 Rail Cut 6" Top and Bottom Sections with Reinforcement	Each	\$31.25
RS35MS350	Sample Dartmouth 3-1/2" Top, Bottom Rail & Reinforcement, Include Baluster & Bracket	Each	\$14.36
RS35MS400	Sample Dartmouth 4" Top, Bottom Rail & Reinforcement, Include Baluster & Bracket	Each	\$14.50
RS40MSFT	Sample Hampton Flat Top, Bottom Rail & Reinforcement, Include Baluster & Bracket	Each	\$12.40
RS40MSFT-M	Sample Hampton Flat/Mahogany Top, Bottom Rail & Reinforcement, Include Baluster & Bracket	Each	\$13.40
RS40MSPT	Sample Hampton Peaked Top, Bottom Rail & Reinforcement, Include Baluster & Bracket	Each	\$12.40
RS50500SAMP	Nautilus RS50500 5" Top Cap Rail 6" Sample, Top & Baluster Cap, Bottom Rail, Include Reinforcement	Each	\$22.42
RS50SAMPLE	RS50 5" Gooseneck Rail Sample, 36" Section, Top Rail Only, with Reinforcement, Prime Coat Applied	Each	\$134.19
RS60MS275	Sample Liberty 2-3/4" Graspable Top, Bottom Rail & Reinforcement, Include Baluster & Bracket	Each	\$12.17
RS60MS350	Sample Liberty 3-1/2" Top, Bottom Rail & Reinforcement, Include Baluster & Bracket	Each	\$12.31
RS60STAIRSAMP	RS60 Salesman Stair Sample, Routed Common Rails, with (2) Short Stair Balusters	Each	\$17.43

**RAILING FLOOR/COUNTER DISPLAYS**

RS40RAILDISP	Display, RS40 Hampton Rail, Include Flat & Peak Rail with 5" Newel Cover & Plain Cap, Includes Graphics and Literature	Each	\$282.59
RS35RAILDISP	Display, RS30 Rail System, Include RS30350 and RS30400 with 5" Newel Cover & Plain Cap, Includes Graphics and Literature	Each	\$311.92
RS60RAILDISP	Display, RS60 Liberty Series, Include 3-1/2" and 2-3/4" (Graspable) Section, with 5" Newel, Molded Base Trim and Flat Cap. Includes Graphics and Literature	Each	\$286.57
RS20MINIDISP	Display, Mini Size, RS20500 Rail with 1 Side Mahogany Top, 1 PVC Top, with 6" Newel & Pyramid Cap	Each	\$258.09
RS40MINIDISP	Mini Hampton Counter Display, Include RS40350F and RS40350P with 5" Newel and Flat Cap/WM75 Base Trim	Each	\$168.01

**WINDOW SURROUND SAMPLE**

SURSAMPLEHALF	Salesman Sample, Half Surround, with WM52 Crown and 311 Sill on Apron, 5/4 x 4 with J-Channel	Each	\$34.27
---------------	---	------	---------

UPS/Freight Costs.....

Total Cost Charged to Marketing Support Fund.....

# Marketing Materials, Samples and Showroom Displays

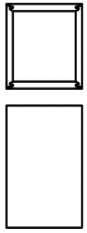

EASYSAMP

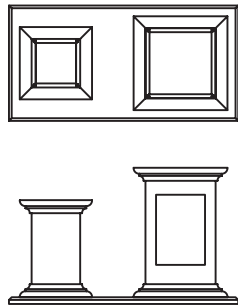

EASYWRAPDISP

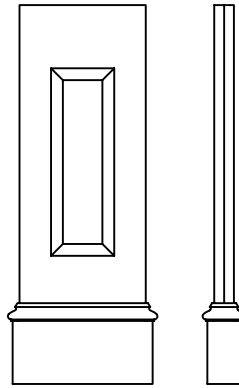

NRE-NRASAMP

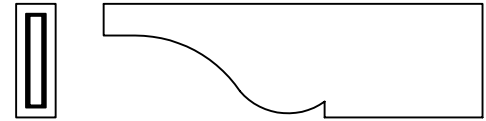

EPR7SAMPLE  
EPR9SAMPLE



PKR5SAMPLE

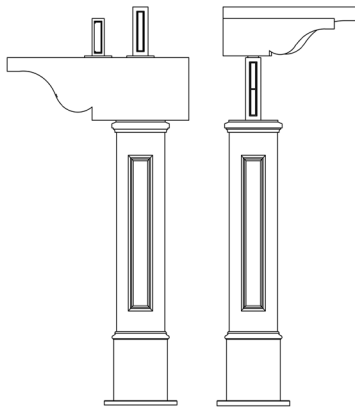

PERGDISP

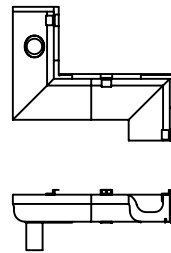

GUTTERCARRY

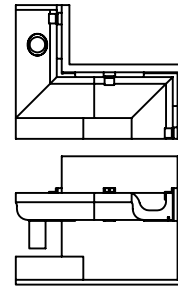

GUTTERDISP

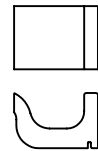

GUTTERSAMP



RS10375SAMP



RS10600SAMP



RS20500SAMP



RS20700SAMP



RS20800SAMP

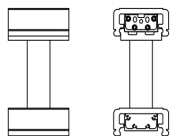

RS35MS350

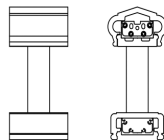

RS35MS400

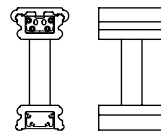

RS40MSFT  
RS40MSFT-M

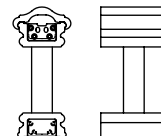

RS40MSPT



# Marketing Materials, Samples and Showroom Displays

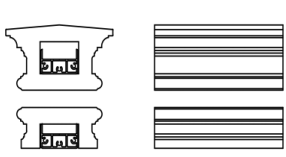

RS50500SAMP

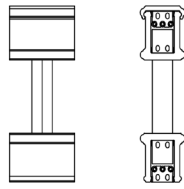

RS60MS275

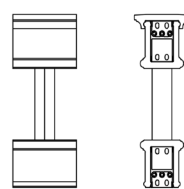

RS60MS350

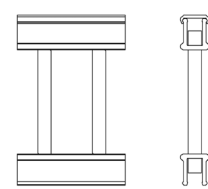

RS60STAIRSAMP

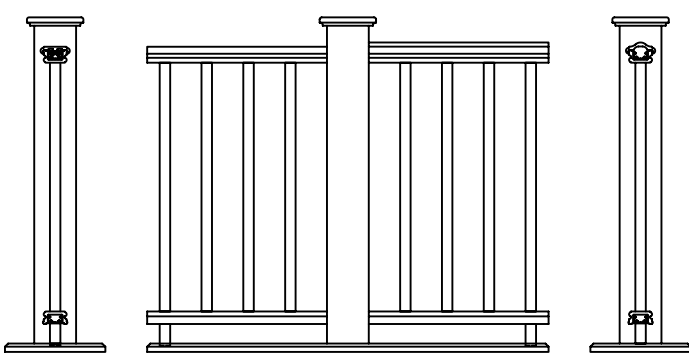

RS40RAILDISP

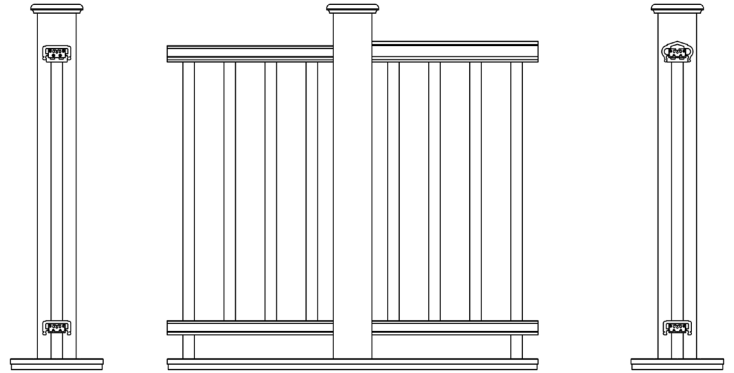

RS35RAILDISP

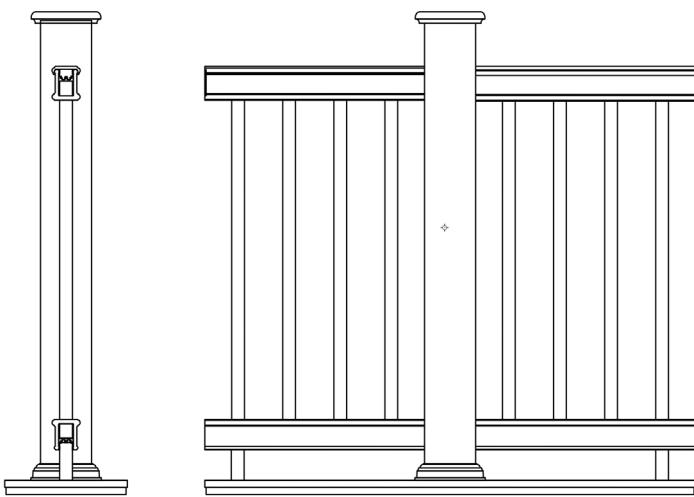

RS60RAILDISP

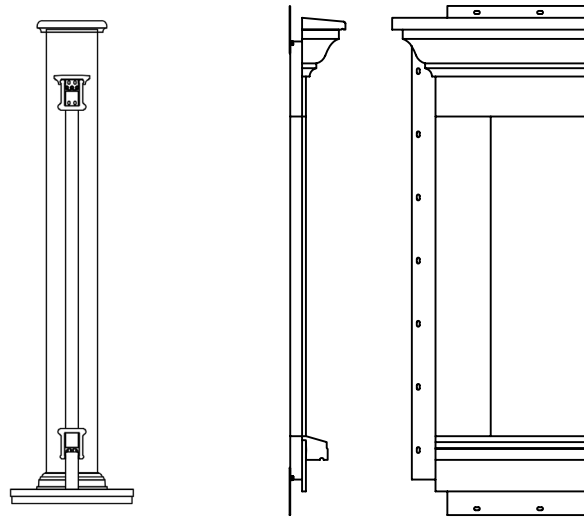

SURSAMPLEHALF

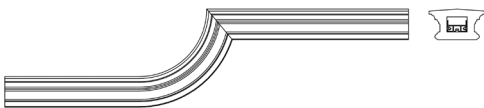

RS50SAMPLE

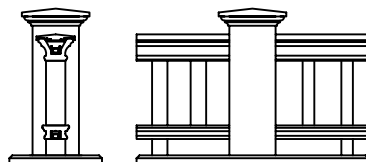

RS20MINIDISP

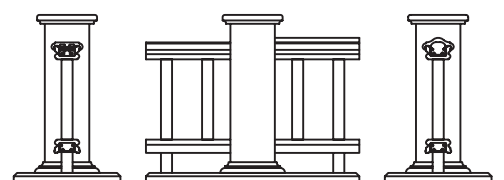

RS40MINIDISP

# Marketing Materials, Samples and Showroom Displays

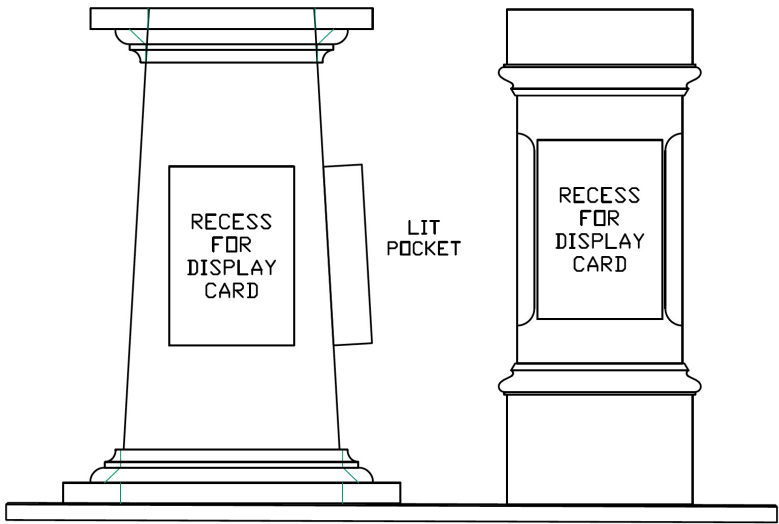

COLUMNDISP

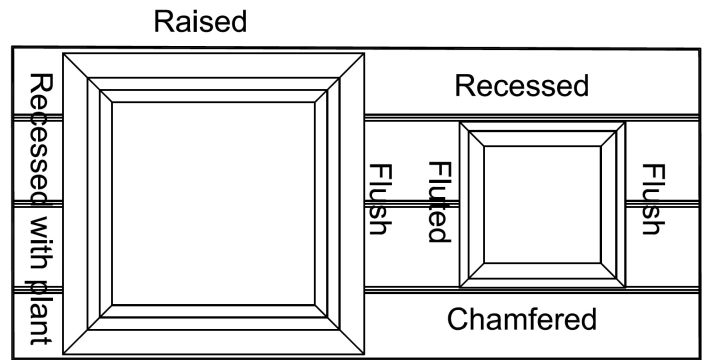

Flush with card

COLUMNDISP - Top View

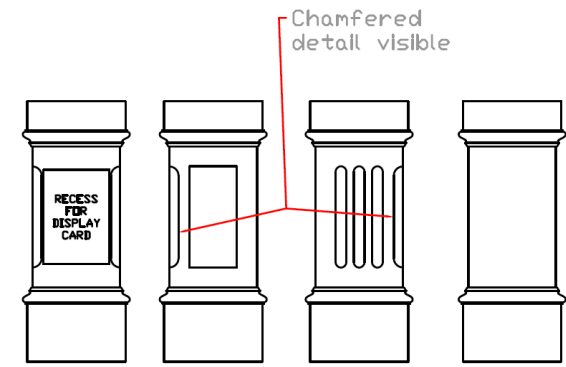

Chamfered detail visible

Chamfered Recessed Fluted Flush

SQCOLSAMP

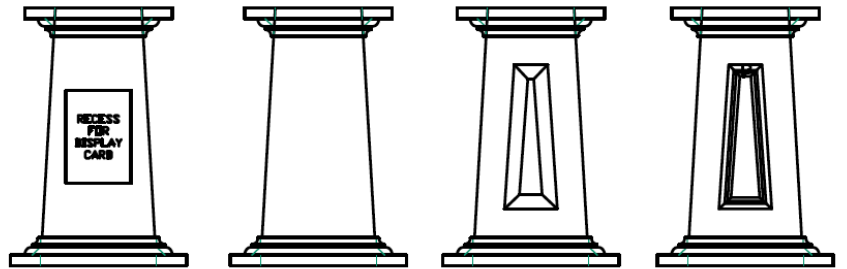

Flush Flush Raised Recessed with plant

TCOLSAMP